

VIBRATION APPLICATION SOLUTIONS

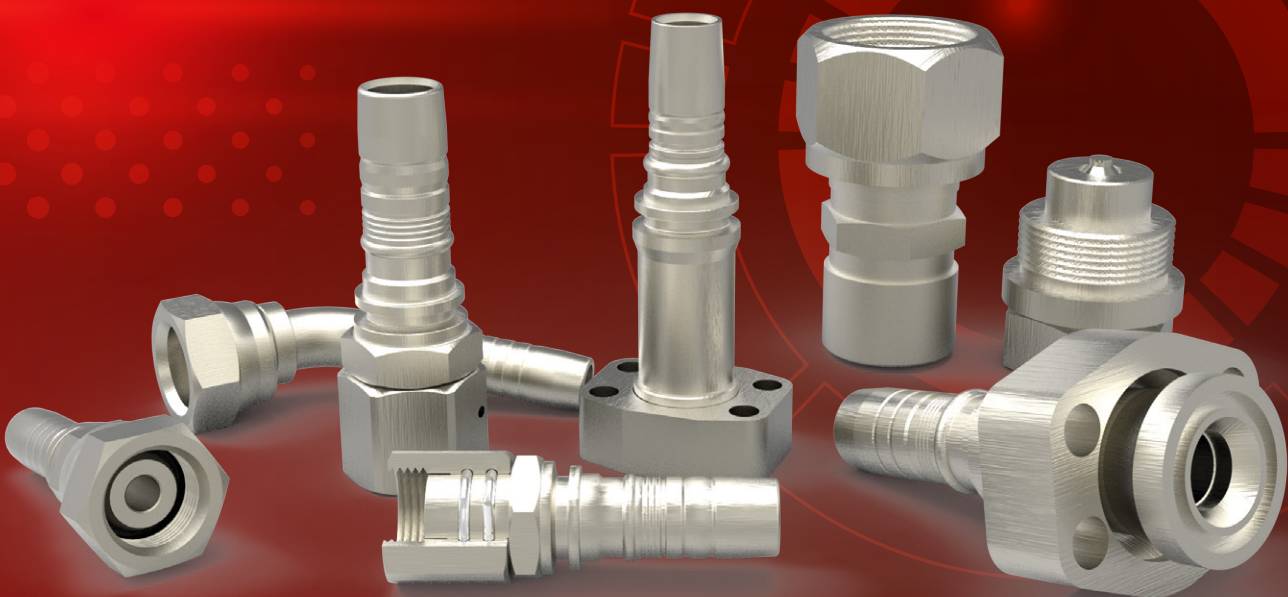

SOLUTIONS FOR HIGH VIBRATION APPLICATIONS



 **manuli**[®]
HYDRAULICS HP

MANULI VIBRATION PRODUCTS

It is fair to say that most hydraulic systems need to incorporate a certain degree of system vibration into their design, especially when it comes to the interconnecting assets such as hoses and fittings. However, whilst many applications simply produce minor levels of system vibration as a by-product of normal operation, there are some applications where extreme vibration is the desired end result.

Applications such as road-compactors, hydraulic hammers and drilling equipment require high levels of vibration to adequately perform their functions. These extreme operational conditions can often lead to certain failures in hydraulic connectors that are rarely seen in other less severe applications, with one of the main causes of failure coming from fittings and couplings literally being shaken apart.

Manuli Hydraulics has solved this, and other high-vibration related issues by the introduction of their **Vibration Products** range of hoses and fittings.

Specifically designed to resist the combination of excessive internal component wear, high untightening torques and frequent high-pressure impulses, the Manuli Vibration Products range provides long-lasting, reliable connections in situations where other connectors will fail.



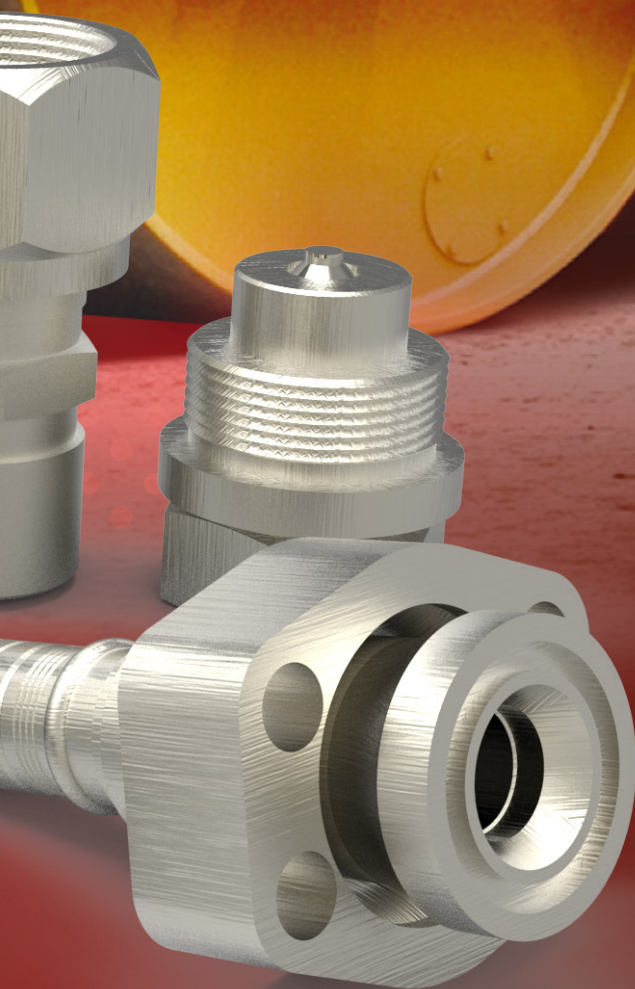

 **manuli**[®]
HYDRAULICS HP

DOUBLE THRUST-WIRE FITTINGS

Available with either JIC (6,000 psi) and BSP (8,000 psi) termination ends, these specially developed double thrust-wire fittings are ideal for use in high-pressure, high-vibration equipment.

Made from high-grade carbon steel and with localised induction hardening on the torque-stressed surfaces, these fittings are some of the most robust and reliable on the market. Designed specifically to resist higher tightening torques and internal wear, the double thrust wire also provides a backup connection between the nut and the fitting.

One of the most common failure modes for thrust-wire fittings is the ejection of the thrust wire due to over-torquing during assembly. To prevent this type of failure the hole through which the thrust-wire was inserted is deformed after insertion, making it almost impossible for the wire to be ejected.

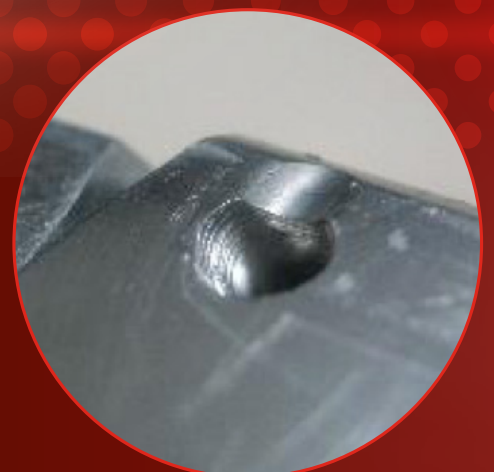
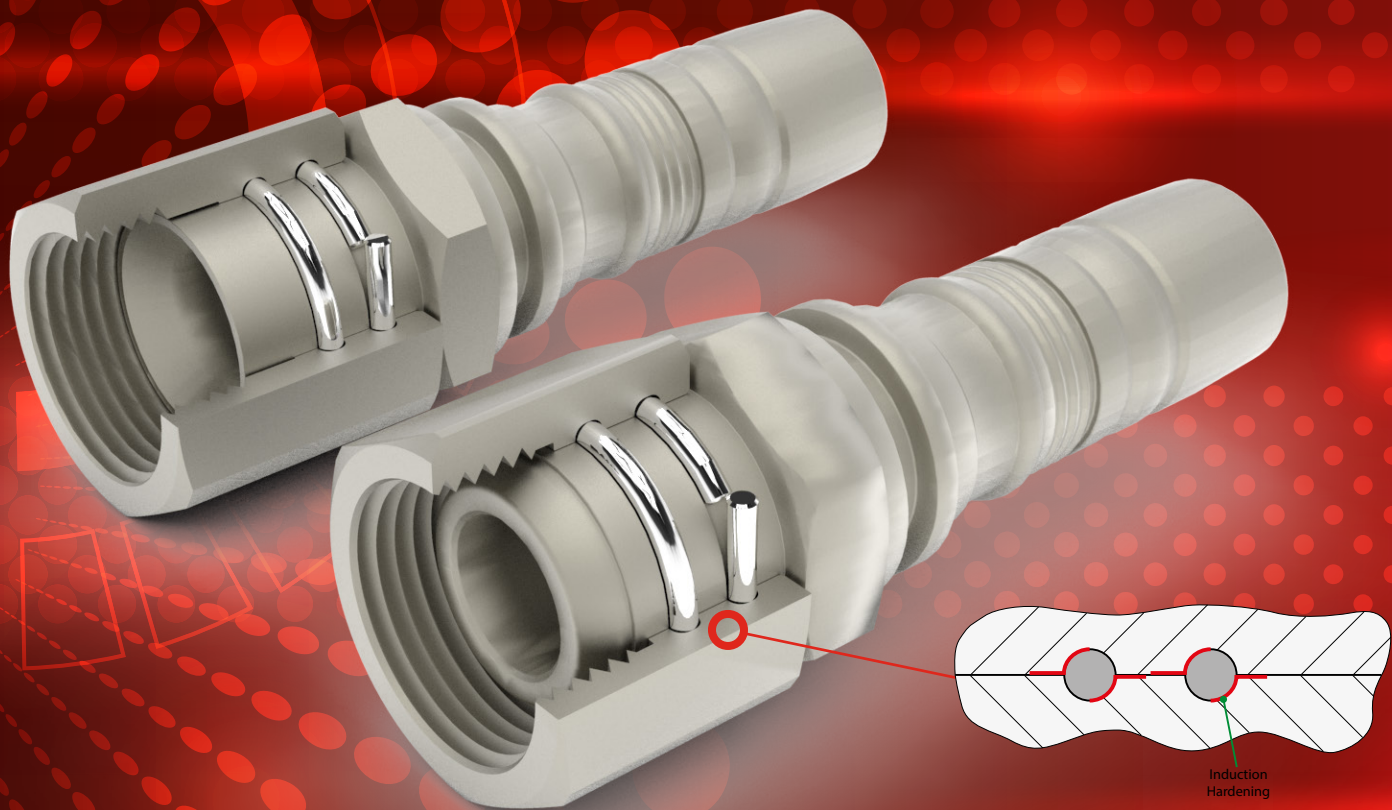

Thrust-wire hole deformed to prevent wire from ejecting

Thrust-wire protruding from termination end

HIGH-TORQUE KR FITTINGS

The Manuli KR style fittings range is specifically designed to minimise the risk of fittings coming loose even under the most severe vibrational conditions.

Made from high-tensile steel with an especially robust design, the Manuli KR fittings range is “designed for abuse” in over-torque situations. With a cracking torque to tightening torque ratio of 3:1, and an over torque ratio of 2:1, the KR range of fittings minimises the risk of accidental damage to the fittings in uncontrolled tightening situations.

In addition, the KR range of fittings have a de-torque value of 70% of the tightening torque - as opposed to the standard 50% de-torquing value. This means that the KR fittings are significantly less likely to come unfastened accidentally, even in high-vibration situations.

The extensive range of KR fittings includes JIC, BSP, ORFS and JIS termination ends, as well as straight, 45°, 90° and long-drop configurations in a range of small- and medium-hose bore sizes.

	Standard Termination Ends	KR Termination Ends
Tightening Torque (TT)	According to or exceeding specs.	TT
Repair / Remedial Torque	1.1 - 1.5 TT	1.1 - 1.5 TT
Over Torque	1.5 - 2.0 TT	2.0 - 2.5 TT
Cracking Torque	2.0 - 2.5 TT	3.0 - 4.0 TT
De-Torque	50% TT	70% TT

This robustness and versatility has led to the KR range becoming the “fittings-of-choice” for several major OEM manufacturers on their heavy duty equipment.



XTR AFLANGE/61 & XTR AFLANGE/62

The Code 61 and Code 62 flange connections are globally accepted as a reliably leak-free solution, especially well-suited to large bore systems.

Manuli Hydraulics offers a wide range of standard Code 61 and Code 62 flange fittings for standard applications. However, for more severe applications, Manuli offer the Xtraflange series.

Fully compatible with Code 61 and Code 62 connection specifications, the Xtraflange series offers a reduced connection footprint as well as an improved pressure rating, from 3,000 psi to 6,000 psi, on the Xtraflange/61 series.

However, the major difference between the Xtraflange series and standard Code 61 and Code 62 flange connections is the unique toroidal clamping surface profile.



THE MANULI ADVANTAGE

The primary weakness of standard Code 61 and Code 62 connections is the huge amount of stress that the clamp imparts on the flange shoulder of the fitting.

Under normal usage conditions this is not generally a major problem; however, under severe vibrational conditions the uni-directional clamping force can cause the flange to crack. The corner of the flange shoulder is already a point of high stress concentration, and the additional shear forces caused by vibrations are often enough to cause catastrophic failure of the fitting.

The Manuli Xtraflange series has a unique toroidal clamping profile which allows the clamping stresses to be more evenly distributed over the material of the fitting, rather than being concentrated in a single area. This provides a far more robust clamping action which is ideally suited to situations where severe vibration is inherent in the design.

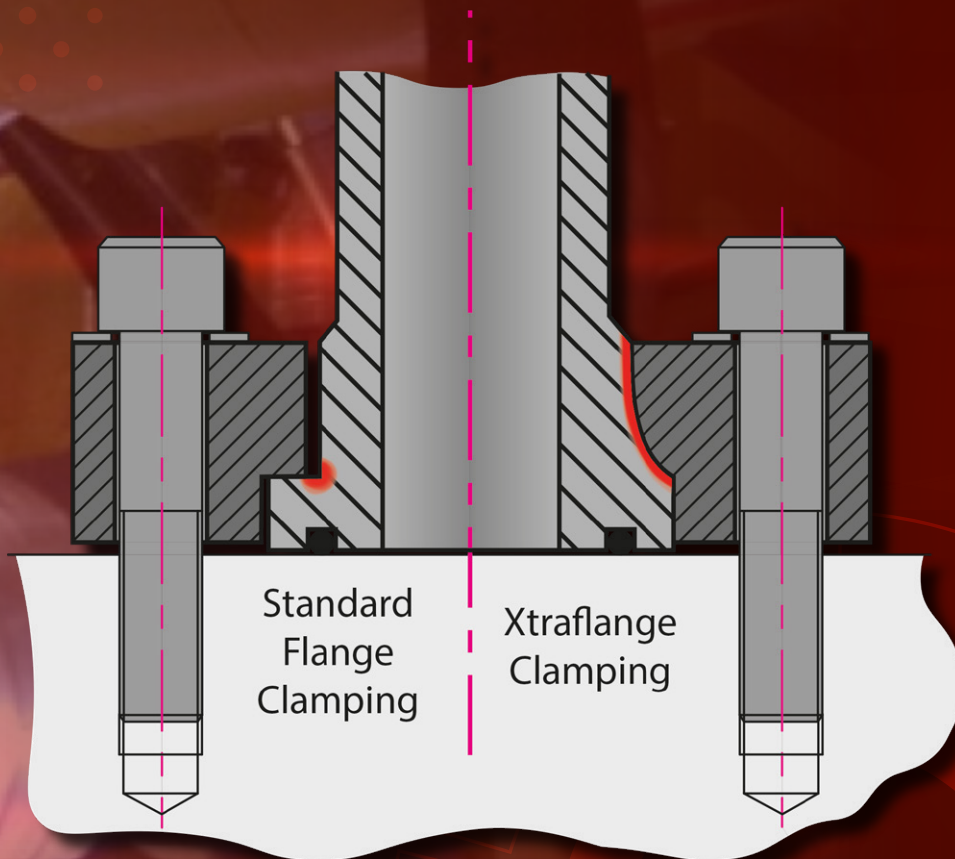

An additional related benefit of the Xtraflange clamping profile, is the improved support that it provides against lateral loading on the upper part of the fitting. By fully contacting the Xtraflange shoulder the clamp and flange essentially become a single solid block, offering a huge improvement in resistance to bending forces. To ensure that they can also handle the stresses, the Xtraflange clamps are made from a high tensile steel, allowing them to have a reduced footprint without sacrificing strength.

MQS-SH - ULTRA HIGH-PRESSURE QUICK COUPLING

Q.Safe is the Manuli Hydraulics offering for quick coupling applications. Composed of more than 1,200 references, accessories and spare parts, the Q.Safe brand has rapidly become an industry byword for quality and performance.

Ruggedly built and designed for maximum pressure resistance, the **Q. Safe MQS-SH ultra high-pressure quick coupling** provides long lasting reliability in even the harshest vibration applications conditions.







Designed especially for applications that would cause lesser products to quickly fail, the MQS-SH quick coupling is unique in the hydraulics field. With a heavy-duty screw-to-connect sleeve, the MQS-SH quick coupling can be connected and disconnected with both male and female parts pressurised up to 30 MPa.

The addition of a hexagon on the sleeve allows the coupling to be mechanically tightened for an even more secure connection and resistance to decoupling in even the most severe vibrational conditions.

- Three-part poppet valve allows connection when pressurised up to 30 MPa
- WP up to 70 MPa in both connected and disconnected conditions
- Hardened poppet valve bodies and moulded shaped seal
- Screw coupling with hexagonal sleeve for minimal connection effort even when system is pressurised
- Mechanical backstop prevents partial closure of valves due to pressure peaks and reverse flow
- Extremely robust construction making it suitable for the toughest applications



TECHNICAL DATA

																
SIZE			WORKING PRES-SURE (Dynamic)		RATED FLOW at 0.2 MPa of pressure drop		OIL SPILLAGE Connection/ Disconnection		MINIMUM BURST PRESSURE						CONNECTION/ DISCONNECTION UNDER PRESSURE	
DN	inch	Dash	MPa	PSI	l/min	US GPM	cc.	cubic inch	Male		Female		M & F			
									MPa	PSI	MPa	PSI	MPa	PSI		
6	¼	04	70	10150	10	2.6	0.4	0.024	290	42050	350	50750	300	43500	Allowed up to 30 MPa	
10	¾	06	60	8700	31	8.2	1.5	0.092	250	36250	330	47850	320	46400	Allowed up to 30 MPa	
12.5	½	08	50	7250	51	13.5	2	0.122	200	29000	260	37700	310	44950	Allowed up to 30 MPa	
20	¾	12	50	7250	102	26.9	4	0.244	200	29000	250	36250	310	44950	Allowed up to 30 MPa	
25	1	16	50	7250	170	44.9	7.5	0.458	200	29000	230	33350	270	39150	Allowed up to 30 MPa	
31	1¼	20	40	5800	325	85.9	15	0.916	160	23200	170	24650	230	33350	Allowed up to 15 MPa	
38	1½	24	32	4640	494	130.5	23	1.404	130	18850	140	20300	150	21750	Allowed up to 15 MPa	

The rated flow represents the normal operating condition. The maximum recommended flow rate is equal to 1.5 times the rated flow

700 bar

Extreme Pressure Rating

VIBRATION TESTING

In order to allow full validation and testing of the Vibration Products range, the Manuli Hydraulics Innovation Centre (MHIC), has invested in a dedicated vibration & impulse testing rig. This rig lets Manuli engineers closely study the effects of vibration on hose assemblies, allowing them to continually improve the Manuli product range.

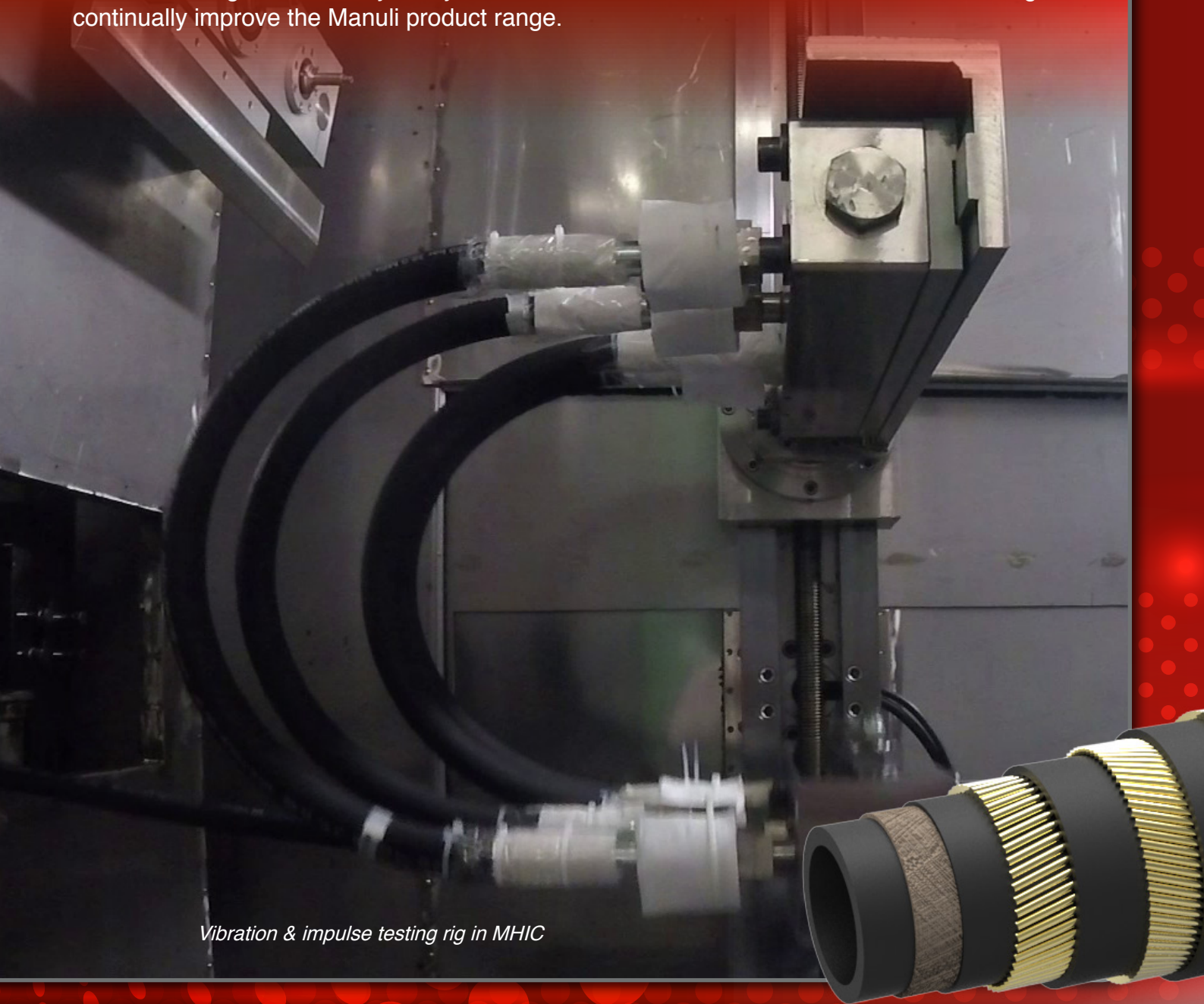

Vibration & impulse testing rig in MHIC

DN	280 bar Applications	350 bar Applications	
16	GoldenISO/35 XF (350 bar)	GoldenISO/42 XF (420 bar)	
19	GoldenISO/35 XF (350 bar)	GoldenISO/42 XF (420 bar); GoldenISO/38 LL (380 bar)	Dia
25	GoldenISO/35 XF (350 bar)	GoldenISO/42 XF (420 bar); GoldenISO/38 LL (380 bar)	Dia
31	GoldenISO/35 XF (350 bar)	GoldenISO/42 XF (420 bar); GoldenISO/38 LL (380 bar)	Dia

Interlock Plus and skive fittings recommended

HOSE SOLUTIONS FOR VIBRATION EQUIPMENT

Although the primary focus for vibration resistant hydraulic connectors is fittings and quick couplings, these specialist products would be of little-to-no use without suitable associated hose solutions.

High vibration can significantly increase the damaging effect of impulse cycles in a hydraulic hose. The most effective solution to this is to upgrade the pressure rating of the hose, therefore effectively increasing the safety factor.

Manuli Hydraulics generally recommends allowing an additional safety margin of around 500 to 1,000 psi when specifying the hose pressure required. To simplify the process we can use the standard isobaric hose pressure levels as a guide. So, if the calculated working pressure for a particular system is 280 bar, we would specify a 350 bar hose for use in a high vibration application. Similarly, we would upgrade a 350 bar hose to a 380 bar or 420 bar hose; and a 420 bar hose to a 450 bar or 560 bar hose for the most extreme applications.

The table below illustrates this solution with reference to recommended alternatives to the standard hose solutions. Of course, as the world's leading supplier of integrated connector solutions, each of our suggested alternatives has an appropriately robust fitting solution available.

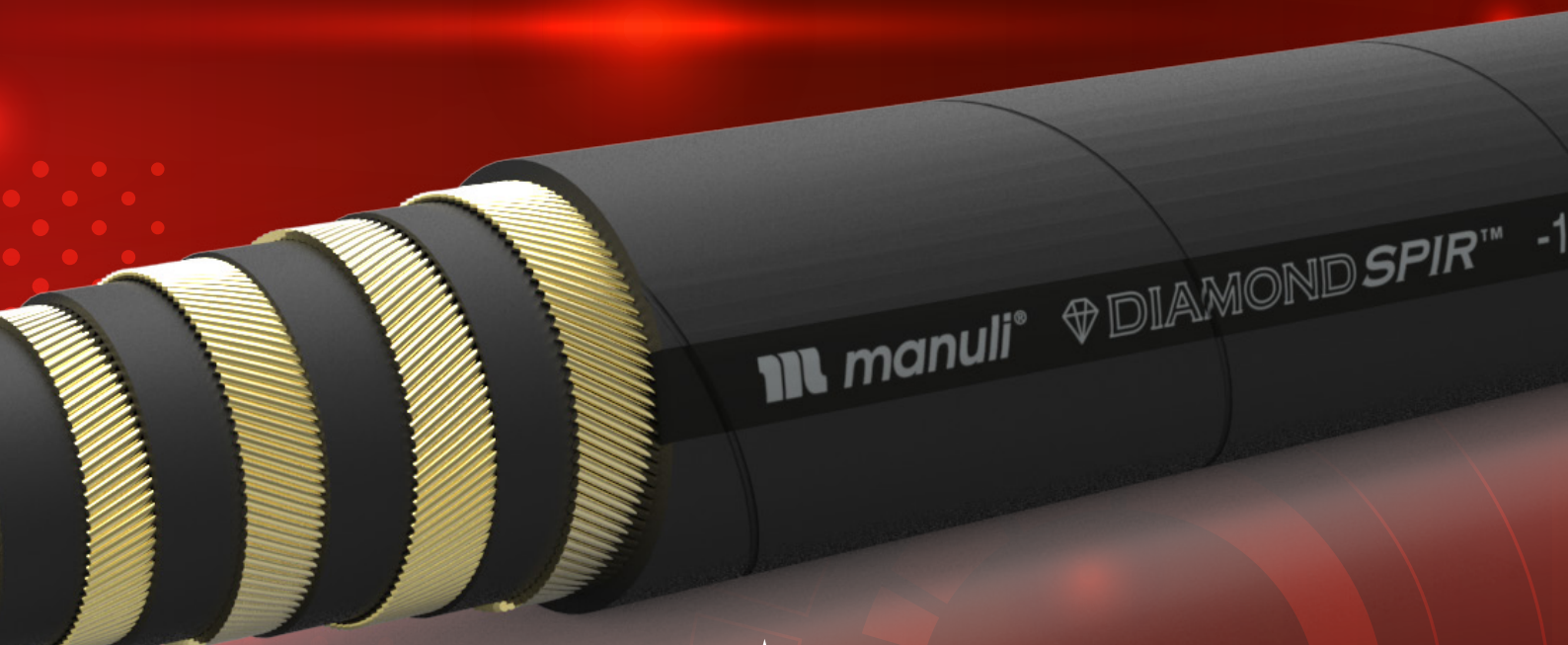

420 bar Applications
GoldenISO/45 LL (460 bar)
DiamondSpir (560 bar); GoldenISO/45 LL (460 bar)
DiamondSpir (560 bar); GoldenISO/45 LL (460 bar)
DiamondSpir (525 bar); GoldenISO/45 LL (450 bar)

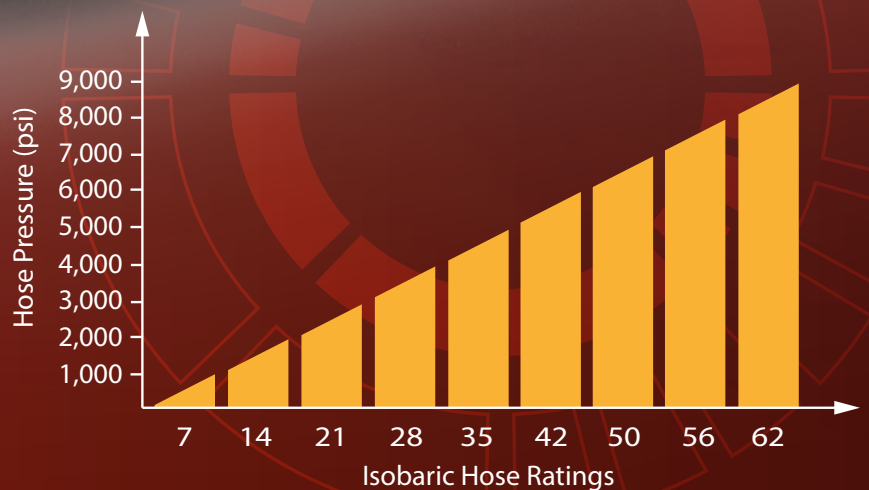

HOSE ASSEMBLY EQUIPMENT

As the global leader in providing integrated solutions for hydraulic connector applications, no dedicated product range from Manuli would be complete without an overview of some of the equipment available to create the final hose assemblies.

Manuli Hydraulics offers a wide range of hose assembly equipment aimed at various different sized assembly operations. As vibration products tend toward the larger end of the hose assembly spectrum, we have identified a few items of assembly equipment which are appropriate for mid- to high-volume assembly operations.

GOLDENCRIMP 420 – HEAVY DUTY HOSE CRIMPING SOLUTION

With a crimping force of 420 tonnes the GoldenCrimp 420 offers a maximum hose crimping diameter of 3”.

Available with one of three different interfaces, including Manuli’s proprietary Safe Crimp System (SCS), the level of automation and sophistication of the GoldenCrimp 420 software can be tailored to suit your precise needs.

KEY FEATURES

- Robust design for transport and operation in harsh environments
- High crimping force of 420 tonnes
- Large opening suitable for large bore hoses
- Extensive range of dies to suit crimping of both industrial and hydraulic hoses
- Easy die setup with ergonomically designed quick-change gun



M205 SKY

Ideal for high-volume assemblers, OEM production units and special application operations.

With optional speed control and hose clamping system, the M205 SKY is capable of both internal and external skiving of hoses up to 3"/ DN48.

KEY FEATURES

- Plug 'n skive system
- Large dust collector
- Robust and easily adjustable knife for quick and simple changeover
- 2-way rotation with optional speed control
- Optional hose clamping system for hoses up to 2"/ DN51

M55 CUT

Designed for cutting hoses up to 2"/ DN51 (6WS), the M55 CUT is a versatile addition to any assembly operation.

Often found in full service workshops and after-market service operations, the M55 CUT is also suitable for small / medium OEM production units where its pneumatic hose bending option and slotted blade allows a high quality, smoke-free cut.

KEY FEATURES

- Smoke-free, high performance cutting
- Ergonomic, functional design with double foot-pedal system
- Safety cover and feed guides for easy, safe and quick cutting operation
- Digital counter and digital maintenance assistance

DIAMONDSPIR

VERY HIGH PRESSURE



TECHNICAL DATA

PART REF.	HOSE SIZE			R.O.D		O.D		MAX. W.P		BURST		MIN. BEND		WEIGHT		FITTINGS	
	DN	dash	inch	mm	inch	mm	inch	bar	psi	bar	psi	mm	inch	g/m	lb/ft	Std 1	Std 2
H10018019*	19	-12	3/4"	29.1	1.15	32.1	1.26	560	8,120	2,240	32,480	280	11.02	1,660	1.12	IP+M01850-12	
H10018025*	25	-16	1"	38.2	1.50	41.2	1.62	560	8,120	2,240	32,480	350	13.78	2,910	1.96	IP+M01850-16	
H10018032*	31	-20	1.1/4"	47.7	1.88	50.9	2.00	525	7,610	2,100	30,450	420	16.54	4,210	2.83	IP+M01850-20	
H10018038*	38	-24	1.1/2"	55.2	2.17	58.7	2.31	475	6,880	1,900	27,550	500	19.69	5,230	3.51	IS+M02700-24	
H10018051*	51	-32	2"	68.4	2.69	71.9	2.83	420	6,090	1,680	24,360	600	23.62	6,680	4.49	IS+M02700-32	

KEY FEATURES

- Very high pressure resistance
- Validated for high fatigue resistance
- Superior abrasion resistance
- High ozone and weather resistance
- Flame resistance to a wide range of specs.
- Antistatic and antitoxic cover
- BIO Biological and mineral oils compatibility

APPLICATIONS & FLUIDS

- Hydraulics: heavy duty power lines, hydrostatic transmissions, in severe environmental conditions, specific installations with tough abrasion conditions, off-shore applications, underground and open pit mining
- Mineral oils, vegetable oils and synthetic ester based oils (up to 100°C/212°F), glycols and polyglycols, mineral oils in aqueous emulsion, water

CONTINUOUS SERVICE TEMPERATURE RANGE

-40 °C, -40 °F
121 °C, 250 °F

TUBE

Oil resistant synthetic rubber

REINFORCEMENT

Six high tensile steel spirals (DN 25-76). Four high tensile steel spirals (DN 19)

COVER

STRONG - TYPE "SD"
Synthetic rubber with high abrasion, ozone, weather and heat resistance

APPLICABLE SPECS

Manuli® Design exceeds ISO 3862 R15

TYPE APPROVALS

ABS; FRAS; CU-TR; MSHA; MA

GOLDENISO/45 LONGLIFE

HIGH FATIGUE RESISTANCE



TECHNICAL DATA

PART REF.	HOSE SIZE			R.O.D		O.D		MAX. W.P		BURST		MIN. BEND		WEIGHT		FITTINGS	
	DN	dash	inch	mm	inch	mm	inch	bar	psi	bar	psi	mm	inch	g/m	lb/ft	Std 1	Std 2
H10089006*	6	-4	1/4"	14.7	0.58	17.1	0.67	460	6,670	1,840	26,680	125	4.92	567	0.38	IP+M01500-04	
H10089016*	16	-10	5/8"	25.5	1.00	28.5	1.12	460	6,670	1,840	26,680	250	9.84	1,290	0.87	IP+M01500-10	
H10089019*	19	-12	3/4"	28.4	1.12	32.0	1.26	460	6,670	1,840	26,680	280	11.02	1,530	1.03	IP+M01500-12	
H10089025*	25	-16	1"	35.4	1.39	38.2	1.50	460	6,670	1,840	26,680	340	13.39	2,150	1.44	IP+M01500-16	
H10089031*	31	-20	1.1/4"	46.3	1.82	49.5	1.95	450	6,520	1,800	26,100	420	16.54	3,790	2.55	IP+M01800-20	
H10089038*	38	-24	1.1/2"	54.2	2.13	58.0	2.28	450	6,520	1,800	26,100	450	17.72	5,002	3.36	IP+M01600-24	

KEY FEATURES

- Designed for original equipment
- Long-term mission profile in severe applications
- Over standard pressure rating
- High impulse resistance exceeding the ISO 18752 requirements
- Superior abrasion resistance
- High ozone and weather resistance
- Flame retardant and antistatic properties of the cover
- Wide compatibility with hydraulic fluids, mineral and biodegradable oils
- Low bend radius, better than the standard requirements
- Interlock-Plus easy mounting system for a very high-level robustness
- Isobaric pressure rating for easy selection and product management

APPLICATIONS & FLUIDS

- Heavy duty pressure lines, hydrostatic transmissions, heavy duty earth moving equipment, hydraulic presses, drilling applications, injection moulding machines, specific installations with severe abrasion conditions and/or harsh environmental conditions, marine applications, underground and open pit mining
- Mineral oils, vegetable oils and synthetic ester based oils (up to 100°C/212°F), glycols and polyglycols, mineral oils in aqueous emulsion, water

CONTINUOUS SERVICE TEMPERATURE RANGE

-40 °C, -40 °F

121 °C, 250 °F

TUBE

Oil resistant synthetic rubber

REINFORCEMENT

Four high tensile steel wire spirals (DN 6-25). Six high tensile steel wire spirals (DN 31-38)

COVER

STRONG - TYPE "SC"

Synthetic rubber with high abrasion, ozone, weather and heat resistance and an extended operational temperature range

APPLICABLE SPECS

Manuli® Design exceeds SAE J517 Type 100R15; ISO 3862 R15; ISO 18752-D extension

TYPE APPROVALS

CU-TR; MSHA; FRAS

GOLDENISO/38 LONGLIFE

HIGH FATIGUE RESISTANCE



TECHNICAL DATA

PART REF.	HOSE SIZE			R.O.D		O.D		MAX. W.P		BURST		MIN. BEND		WEIGHT		FITTINGS	
	DN	dash	inch	mm	inch	mm	inch	bar	psi	bar	psi	mm	inch	g/m	lb/ft	Std 1	Std 2
H10098006*	6	-4	1/4"	11.3	0.44	13.1	0.52	380	5,510	1,680	24,360	45	1.77	284	0.19	MF+M00120-04	
H10098008*	8	-5	5/16"	12.9	0.51	14.7	0.58	380	5,510	1,680	24,360	55	2.17	318	0.21	MF+M00120-05	
H10098010*	10	-6	3/8"	15.5	0.61	17.1	0.67	380	5,510	1,680	24,360	65	2.56	440	0.30	MF+M00120-06	
H10098012*	12	-8	1/2"	18.6	0.73	20.6	0.81	380	5,510	1,680	24,360	80	3.15	573	0.39	MF+M00120-08	
H10098019*	19	-12	3/4"	27.7	1.09	32.0	1.26	380	5,510	1,680	24,360	170	6.69	1,410	0.95	IP+M01500-12	
H10098025*	25	-16	1"	34.8	1.37	38.1	1.50	380	5,510	1,680	24,360	220	8.66	1,964	1.32	IP+M01500-16	
H10098031*	31	-20	1.1/4"	46.3	1.82	49.5	1.95	380	5,510	1,680	24,360	267	10.51	3,663	2.46	IP+M01600-20	

KEY FEATURES

- Designed for original equipment
- Long-term mission profile in severe applications
- Over standard pressure rating
- High impulse resistance exceeding the ISO 18752 requirements
- Superior abrasion resistance
- High ozone and weather resistance
- Flame retardant and antistatic properties of the cover
- Wide compatibility with hydraulic fluids, mineral and biodegradable oils
- Low bend radius, better than the standard requirements
- Interlock-Plus easy mounting system for a very high-level robustness
- Isobaric pressure rating for easy selection and product management

APPLICATIONS & FLUIDS

- Heavy duty pressure lines, hydrostatic transmissions, heavy duty earth moving equipment, hydraulic presses, drilling applications, injection moulding machines, specific installations with severe abrasion conditions and/or harsh environmental conditions, marine applications, underground and open pit mining
- Mineral oils, vegetable oils and synthetic ester based oils (up to 100°C/212°F), glycols and polyglycols, mineral oils in aqueous emulsion, water

CONTINUOUS SERVICE TEMPERATURE RANGE

-46 °C, -50 °F

121 °C, 250 °F

TUBE

Oil resistant synthetic rubber

REINFORCEMENT

Two high tensile steel wire braids (DN 6 - 12), four high tensile steel wire spirals (DN 19 & 25), six high tensile steel wire spirals (DN 31)

COVER

STRONG - TYPE "SC"

Synthetic rubber with high abrasion, ozone, weather and heat resistance and an extended operational temperature range

APPLICABLE SPECS

Manuli® Design: DN 6 to 12 exceeds ISO 18752-C extension; DN 19 to 31 exceeds SAE J517 Type 100R13; ISO 3862 R13; ISO 18752-C-D extension

TYPE APPROVALS

CU-TR; MSHA; FRAS

GOLDENISO/42 XTRAFLEX

COMPACTNESS AND FLEXIBILITY

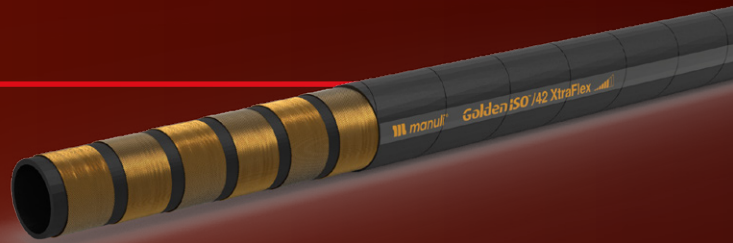

TECHNICAL DATA

PART REF.	HOSE SIZE			R.O.D		O.D		MAX. W.P		BURST		MIN. BEND		WEIGHT		FITTINGS	
	DN	dash	inch	mm	inch	mm	inch	bar	psi	bar	psi	mm	inch	g/m	lb/ft	Std 1	Std 2
H10097006*	6	-4	1/48"	11.3	0.44	13.1	0.52	420	6,090	1,680	24,360	45	1.77	284	0.19	MF+M00120-04	
H10097010*	10	-6	3/8"	17.6	0.69	20.0	0.79	420	6,090	1,680	24,360	100	3.94	688	0.46	MF+M00910-06	
H10097012*	12	-8	1/2"	20.3	0.80	22.7	0.89	420	6,090	1,680	24,360	120	4.72	807	0.54	MF+M00910-08	
H10097016*	16	-10	5/8"	23.9	0.94	26.4	1.04	420	6,090	1,680	24,360	140	5.51	989	0.66	IP+M01500-10	SP+M05400-10
H10097019*	19	-12	3/4"	27.7	1.09	30.2	1.19	420	6,090	1,680	24,360	150	5.91	1,285	0.86	IP+M01500-12	SP+M05400-12
H10097025*	25	-16	1"	34.8	1.37	37.3	1.47	420	6,090	1,680	24,360	210	8.27	2,007	1.35	IP+M01500-16	SP+M05400-16
H10097031*	31	-20	1.1/4"	46.3	1.82	49.5	1.95	420	6,090	1,680	24,360	260	10.24	3,663	2.46	IP+M01600-20	SP+M05500-20
H10097038*	38	-24	1.1/2"	53.2	2.09	56.4	2.22	420	6,090	1,680	24,360	310	12.20	4,450	2.99	IP+M01600-24	SPGX+M05500-24GX
H10097051*	51	-32	2"	68.9	2.71	72.4	2.85	420	6,090	1,680	24,360	500	19.69	7,310	4.91	IS+M02700-32	SPGX+M05500-32GX

KEY FEATURES

- Bend radius which exceeds the standard requirements by - 30% to -50%
- Good flexibility in the whole temperature range
- Easy mounting in any installation
- High impulse resistance according to ISO 18752 requirements
- Weight saving of 20% vs traditional R15 hose construction
- No-skive fitting solution is available
- Isobaric pressure rating for easy selection and product management

APPLICATIONS & FLUIDS

- High pressure power lines for general hydraulics
- Heavy duty power lines
- Applications with installation constraints (short assemblies, compact spaces, low bend radii, etc.)
- Mineral oils, vegetable oils and synthetic ester based oils (up to 100°C/212°F), glycols and polyglycols, mineral oils in aqueous emulsion, water

CONTINUOUS SERVICE TEMPERATURE RANGE

-46 °C, -50 °F

121 °C, 250 °F

TUBE

Oil resistant synthetic rubber

REINFORCEMENT

Two high tensile steel wire braids (DN 6). Four high tensile steel spirals (DN 10-31). Six high tensile steel spirals (DN 38-51).

COVER

STRONG - TYPE "SC"

Synthetic rubber with high abrasion, ozone, weather and heat resistance and an extended operational temperature range

APPLICABLE SPECS

ISO 18752-C (Grade C "Plus" approved 1 Mil impulse cycles with Interlock Plus fittings), meets and exceed ISO 3862-R15 performance

TYPE APPROVALS

CU-TR; MSHA; FRAS; B; ABS; BV; LR; RINA; DNV-GL(MED); DNV-GL; MA

REMARKS



- Size -20 is qualified to reduced bend radius with Interlock Plus fitting solution
-20: MBR = 210mm

GOLDENISO/35 XTRAFLEX

COMPACTNESS AND FLEXIBILITY

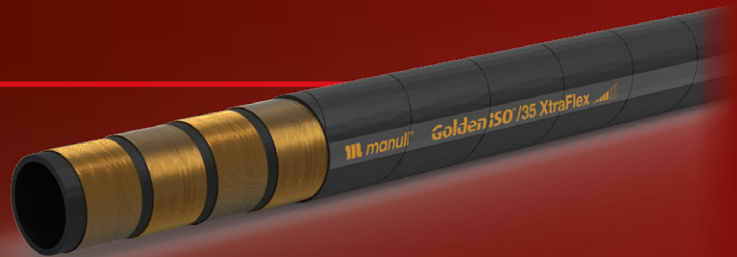

TECHNICAL DATA

PART REF.	HOSE SIZE			R.O.D		O.D		MAX. W.P		BURST		MIN. BEND		WEIGHT		FITTINGS	
	DN	dash	inch	mm	inch	mm	inch	bar	psi	bar	psi	mm	inch	g/m	lb/ft	Std 1	Std 2
H10096010*	10	-6	3/8"	16.7	0.66	18.9	0.74	350	5,070	1,400	20,300	80	3.15	530	0.36	MF+M00910-06	OPK-06
H10096012*	12	-8	1/2"	19.6	0.77	21.8	0.86	350	5,070	1,400	20,300	90	3.54	660	0.44	MF+M00910-08	OPK-08
H10096016*	16	-10	5/8"	23.5	0.93	25.7	1.01	350	5,070	1,400	20,300	100	3.94	934	0.63	MF+M00910-10	OPK-10
H10096019*	19	-12	3/4"	27.5	1.08	29.9	1.18	350	5,070	1,400	20,300	120	4.72	1,220	0.82	IP+M01500-12	SP+M05400-12
H10096025*	25	-16	1"	34.6	1.36	37.0	1.46	350	5,070	1,400	20,300	150	5.91	1,800	1.21	IP+M01500-16	SP+M05400-16
H10096031*	31	-20	1.1/4"	42.1	1.66	44.9	1.77	350	5,070	1,400	20,300	230	9.06	2,340	1.57	IP+M01500-20	SP+M05400-20
H10096038*	38	-24	1.1/2"	52.9	2.08	56.1	2.21	350	5,070	1,400	20,300	300	11.81	4,165	2.80	IP+M01600-24	SP+M05500-24
H10096051*	51	-32	2"	66.8	2.63	70.4	2.77	350	5,070	1,400	20,300	360	14.17	6,161	4.14	IP+M01800-32	SP+M05500-32

KEY FEATURES

- Bend radius which exceeds the standard requirements by - 30% to -50%
- Good flexibility in the whole temperature range
- Easy mounting in any installation
- High impulse resistance according to ISO 18752 requirements
- Weight saving of 20% vs traditional R15 hose construction
- No-skive fitting solution is available
- Isobaric pressure rating for easy selection and product management

APPLICATIONS & FLUIDS

- High pressure power lines for general hydraulics
- Applications with installation constraints (short assemblies, compact spaces, low bend radii, etc.)
- Mineral oils, vegetable oils and synthetic ester based oils (up to 100°C/212°F), glycols and polyglycols, mineral oils in aqueous emulsion, water

CONTINUOUS SERVICE TEMPERATURE RANGE

-46 °C, -50 °F

121 °C, 250 °F

TUBE

Oil resistant synthetic rubber

REINFORCEMENT

Four high tensile steel spirals (DN 10-31). Six high tensile steel spirals (DN 38, 51).

COVER

STRONG - TYPE "SC"

Synthetic rubber with high abrasion, ozone, weather and heat resistance and an extended operational temperature range

APPLICABLE SPECS

ISO 18752-C/D, JIS K6349-3, meets and exceed EN 856-R13 & ISO 3862-R13 performance

TYPE APPROVALS

DNV-GL; CU-TR; MSHA; FRAS; B; ABS; BV; LR; RINA; DNV-GL(MED); MA

SAE STANDARD CONNECTIONS

M42714

JIC
 FEMALE 37° CONE SEAT
 SAE J516 / ISO 12151-5
 (DOUBLE THRUST-WIRE NUT)

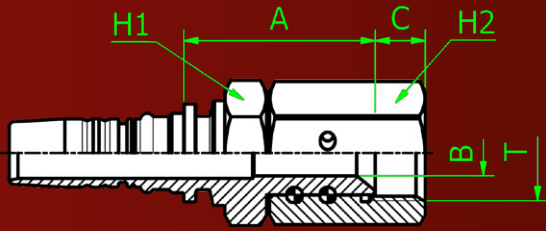

PART. REF.	HOSE BORE			Thread	DIMENSIONS mm							
	DN	Dash	inch		T	B	A	C	H1	H2		
M42714-12-12	19	- 12	3/4"	1.1/16" - 12		13.0	55.0	14.4	36.0	36.0		
M42714-16-16	25	- 16	1"	1.5/16" - 12		18.0	60.5	15.1	41.0	41.0		
M42714-20-20	31	- 20	1.1/4"	1.5/8" - 12		23.0	71.0	15.9	50.0	55.0		
M42714-24-24	38	- 24	1.1/2"	1.7/8" - 12		27.0	71.0	18.6	55.0	60.0		
M42714-32-32	51	- 32	2"	2.1/2" - 12		37.0	77.5	23.8	70.0	75.0		

BS STANDARD CONNECTIONS

M40514

BSP
 FEMALE 60° CONE
 BS5200 / ISO 12151-6
 (DOUBLE THRUST-WIRE)

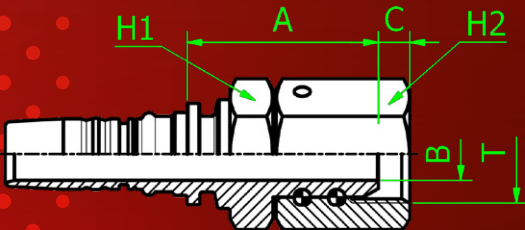

PART. REF.	HOSE BORE			Thread	DIMENSIONS mm							
	DN	Dash	inch		T	B	A	C	H1	H2		
M40514-12-12	19	- 12	3/4"	3/4" - 14		14.5	53.0	8.7	36.0	36.0		
M40514-16-16	25	- 16	1"	1" - 11		18.0	58.0	11.1	41.0	41.0		
M40514-20-20	31	- 20	1.1/4"	1.1/4" - 11		23.0	75.0	10.1	50.0	55.0		
M40514-24-24	38	- 24	1.1/2"	1.1/2" - 11		27.0	76.0	12.5	55.0	60.0		



Q.Safe

SCREW TYPE HEAVY DUTY

Pressure Drop

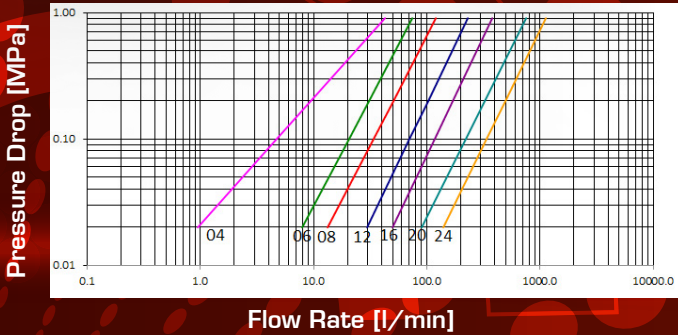

Pressure Drop

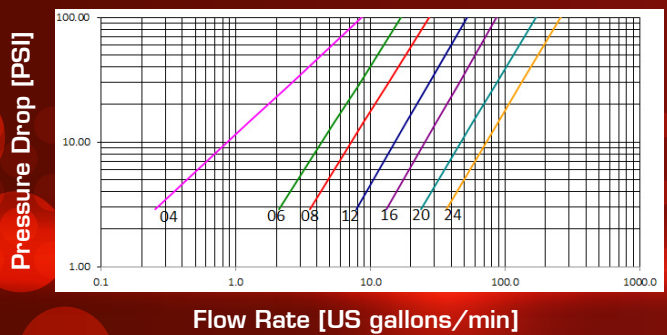

TECHNICAL DATA

SIZE			MPa		FLOW RATE		OIL SPILLAGE Connection/ Disconnection		MINIMUM BURST PRESSURE						CONNECTION/ DISCONNECTION UNDER PRESSURE
DN	inch	Dash	MPa	PSI	l/min	US GPM	cc.	cubic inch	Male		Female		M & F		
									MPa	PSI	MPa	PSI	MPa	PSI	
6	¼	04	70	10150	10	2.6	0.4	0.024	290	42050	350	50750	300	43500	Allowed up to 30 MPa
10	¾	06	60	8700	31	8.2	1.5	0.092	250	36250	330	47850	320	46400	Allowed up to 30 MPa
12.5	½	08	50	7250	51	13.5	2	0.122	200	29000	260	37700	310	44950	Allowed up to 30 MPa
20	¾	12	50	7250	102	26.9	4	0.244	200	29000	250	36250	310	44950	Allowed up to 30 MPa
25	1	16	50	7250	170	44.9	7.5	0.458	200	29000	230	33350	270	39150	Allowed up to 30 MPa
31	1¼	20	40	5800	325	85.9	15	0.916	160	23200	170	24650	230	33350	Allowed up to 15 MPa
38	1½	24	32	4640	494	130.5	23	1.404	130	18850	140	20300	150	21750	Allowed up to 15 MPa

The rated flow represents the normal operating condition. The maximum recommended flow rate is equal to 1.5 times the rated flow

PRODUCT DESCRIPTION

- Screw-on connection/disconnection system
- Sleeve with hexagon area internal components reinforced, made in steel
- Hardened valve bodies
- Three-part poppet valve with a moulded shaped seal
- Mechanical backstop to prevent partial enclosures of valves due to peaks and reverse flow
- Interchangeable with other products and widely used on the market
- Accessories (plugs and caps) and spare part kits available
- Wide range of termination ends

MATERIAL

Couplings in steel with some stressed area hardened. Carbonitrided valve, springs in C98 steel, seals in NBR and back-up ring in PTFE

WORKING TEMPERATURE

-22°F up to +230°F (-30°C up to +110°C)

SAFETY FACTOR

4:1 for dynamic pressures

IMPULSE PRESSURES

200,000 cycles (connected and disconnected conditions) at 120% of the rated one (freq. 1Hz)

TEST SPECIFICATIONS

ISO 18869

Q05411041A Q05311041A

BSP TERMINATION ENDS
TO DIN 3852 X TYPE

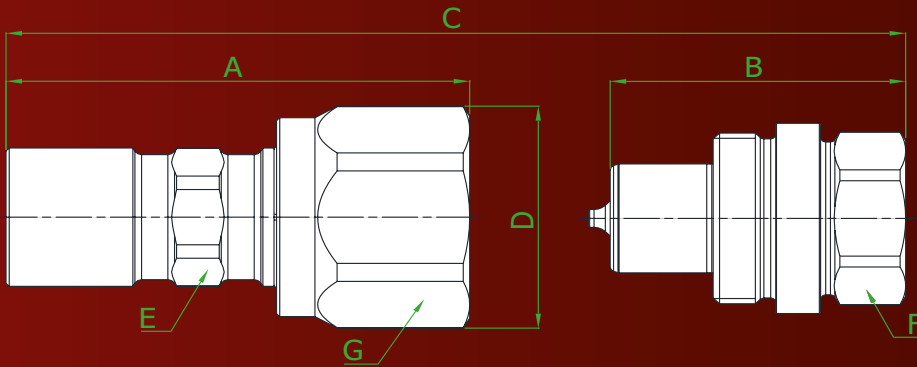

SIZE			PART NUMBER		THREAD	DIMENSIONS mm						
DN	Inch	Dash	Female coupling	Male coupling		A	B	C	D	E	F	G
6.3	1/4"	-04	Q05411041A-04-04	Q05311041A-04-04	1/4"	63	42.2	A+B-20,8	ø35	19	22	32
10	3/8"	-06	Q05411041A-06-06	Q05311041A-06-06	3/8"	72.5	46.2	A+B-25,9	ø38,5	22	27	35
12.5	1/2"	-08	Q05411041A-08-08	Q05311041A-08-08	1/2"	82.1	54.4	A+B-27,3	ø45	27	32	41
20	3/4"	-12	Q05411041A-12-12	Q05311041A-12-12	3/4"	93.7	61.4	A+B-31,9	ø55	35	41	50
25	1"	-16	Q05411041A-16-16	Q05311041A-16-16	1"	105.8	68.3	A+B-37	ø66	41	50	60
31.5	1.1/4"	-20	Q05411041A-20-20	Q05311041A-20-20	1.1/4"	131.9	82	A+B-53,9	ø88	55	70	80
38	1.1/2"	-24	Q05411041A-24-24	Q05311041A-24-24	1.1/2"	158.9	102	A+B-70,4	ø99	60	80	90

Q05411341A Q05311341A

NPTF TERMINATION END
TO ANSI B 1.20.3

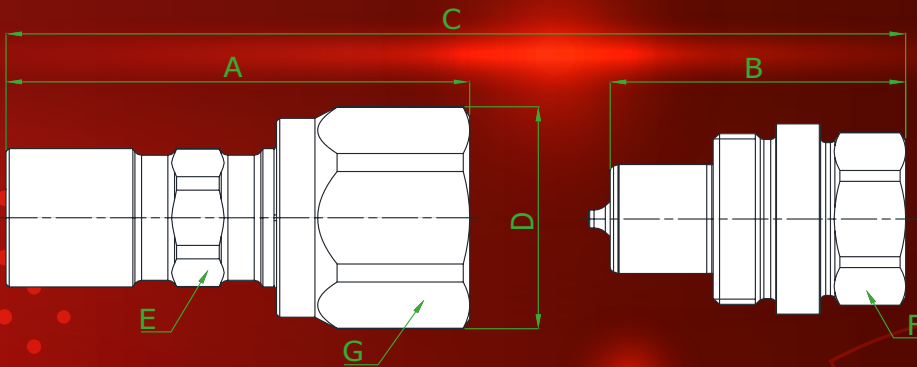

SIZE			PART NUMBER		THREAD	DIMENSIONS mm						
DN	Inch	Dash	Female coupling	Male coupling		A	B	C	D	E	F	G
6.3	1/4"	-04	Q05411341A-04-04	Q05311341A-04-04	1/4" NPTF	63	42.2	A+B-20,8	ø35	19	22	32
10	3/8"	-06	Q05411341A-06-06	Q05311341A-06-06	3/8" NPTF	72.5	46.2	A+B-25,9	ø38,5	22	27	35
12.5	1/2"	-08	Q05411341A-08-08	Q05311341A-08-08	1/2" NPTF	82.1	54.4	A+B-27,3	ø45	27	32	41
20	3/4"	-12	Q05411341A-12-12	Q05311341A-12-12	3/4" NPTF	93.7	61.4	A+B-31,9	ø55	35	41	50
25	1"	-16	Q05411341A-16-16	Q05311341A-16-16	1" NPTF	105.8	68.3	A+B-37	ø66	41	50	60
31.5	1.1/4"	-20	Q05411341A-20-20	Q05311341A-20-20	1.1/4" NPTF	131.9	82	A+B-53,9	ø88	55	70	80
38	1.1/2"	-24	Q05411341A-24-24	Q05311341A-24-24	1.1/2" NPTF	158.9	102	A+B-70,4	ø99	60	80	90



www.manuli-hydraulics.com/hp-hydraulics



Global Marketing Office
Email: marketing@manuli-hydraulics.com

© Copyright 2021 Manuli Hydraulics. All rights reserved.
All product names are either trademarks or registered trademarks of
Manuli Hydraulics or Manuli Rubber Industries unless otherwise stated.