

WATER CLEANING & BLASTING



PRODUCT CATALOGUE

2021

Introduction	4
Index	5
Visual Index	6
1 - HOSES	
Water Blasting Hoses	11
Water Cleaning Hoses	14
2 - FITTINGS	
Multifit Type	25
Blastlock Type	27
3 - APPENDIX	
Blastlock Assembling Instructions	33

The water cleaning hose range offered by Manuli can be applied to both hobby and professional water cleaning machines with both hot and cold water (not suitable for vapour steam applications).

They are designed according to safety norm IEC-2 with a safety factor (burst / working pressure) of 4:1.

The water blasting hose range is designed for maximum robustness and ease of handling.

Given the importance of safety and performance when connected with any blasting application, this range has a complete, dedicated fittings range, whilst the safety factor (burst / working pressure) of 2,5:1 is compliant with international specifications (AS/NZ 4233.2, RMA-USA, ISO7751, BFPA-UK, EN 1829-2).



RANGE	HOSE	HOSE STRUCTURE	KEY PERFORMANCE	PAGE
WATER BLASTING	GOLDENBLAST	Wire spiral	Safe waterblast technology	11
	GOLDENBLAST/PLUS	Wire spiral	Safe waterblast technology	12
	GOLDENBLAST/SIX	Wire spiral	Safe waterblast technology	13
WATER CLEANING	K-JET	Wire braided	Pressure wash	14 - 15
	SUPERJET	Wire braided	Pressure wash	16 - 17
	SUPERJET/PLUS	Wire braided	Pressure wash	18 - 19
	PROJET	Wire braided	Pressure wash	20 - 21

GUIDE TO SELECT MANULI HOSE BY WORKING PRESSURE

HOSE SIZE	WORKING PRESSURE (bar)									
	DN	5	6	8	10	12	16	19	25	
	DASH	-3	-4	-5	-6	-8	-10	-12	-16	
GOLDENBLAST					750	750				Safety factor burst/working pressure 2,5:1
GOLDENBLAST/PLUS					1250	1100		1000	700	
GOLDENBLAST/SIX						1450		1350		
K-JET			210	210	210	210				Safety factor burst/working pressure 4:1
SUPERJET			280	250						
SUPERJET/PLUS			400	350	330	275				
PROJET			400	400	400	350				

WATER CLEANING

MF2000® MULTIFIT TYPE FERRULE

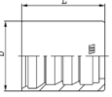
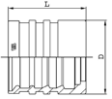
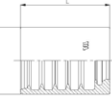
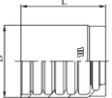
APPEARANCE	CODE	DESCRIPTION	PAGE
	M00120	SKIVE FERRULE FOR WIRE BRAID HOSES	25
	M00910	SKIVE FERRULE FOR WIRE BRAID AND SPIRAL HOSES	25
	M03300	NO-SKIVE FERRULE FOR WIRE BRAID HOSES	25
	M03400	NO-SKIVE FERRULE FOR WIRE BRAID HOSES	26

MF2000® MULTIFIT TYPE INSERT

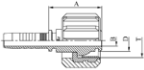
APPEARANCE	CODE	DESCRIPTION	PAGE
	M24913	WASH CLEANER FEMALE	26

WATER BLASTING

MF2000® BLASTLOCK TYPE FERRULE

APPEARANCE	CODE	DESCRIPTION	PAGE
	M01500	DOUBLE SKIVE FERRULE FOR HEAVY DUTY SPIRAL HOSES (4 PLY)	27
	M01700	DOUBLE SKIVE FERRULE FOR HEAVY DUTY SPIRAL HOSES (4 PLY)	27
	M01800	DOUBLE SKIVE FERRULE FOR EXTRA DUTY SPIRAL HOSES (6 PLY)	27

MF2000® BLASTLOCK TYPE INSERT

APPEARANCE	CODE	DESCRIPTION	PAGE
	M57810	NPTF MALE 60° CONE SEAT - SAE J516/J514	28
	M65514	BSP FEMALE 50° CONE - BS5200/ISO 8434-6	28
	M66613	METRIC O-RING FEMALE 24° CONE HEAVY DUTY - DIN 20066/ISO 12151-2 (SLIP-ON NUT)	28

MF3000® OPF TYPE FERRULE

APPEARANCE	CODE	DESCRIPTION	PAGE
	OPF3100	NO-SKIVE FLAT CRIMP FERRULE FOR BRAIDED HOSES	29

HOSES

 **manuli**[®]
CONVEYORS LP & HP



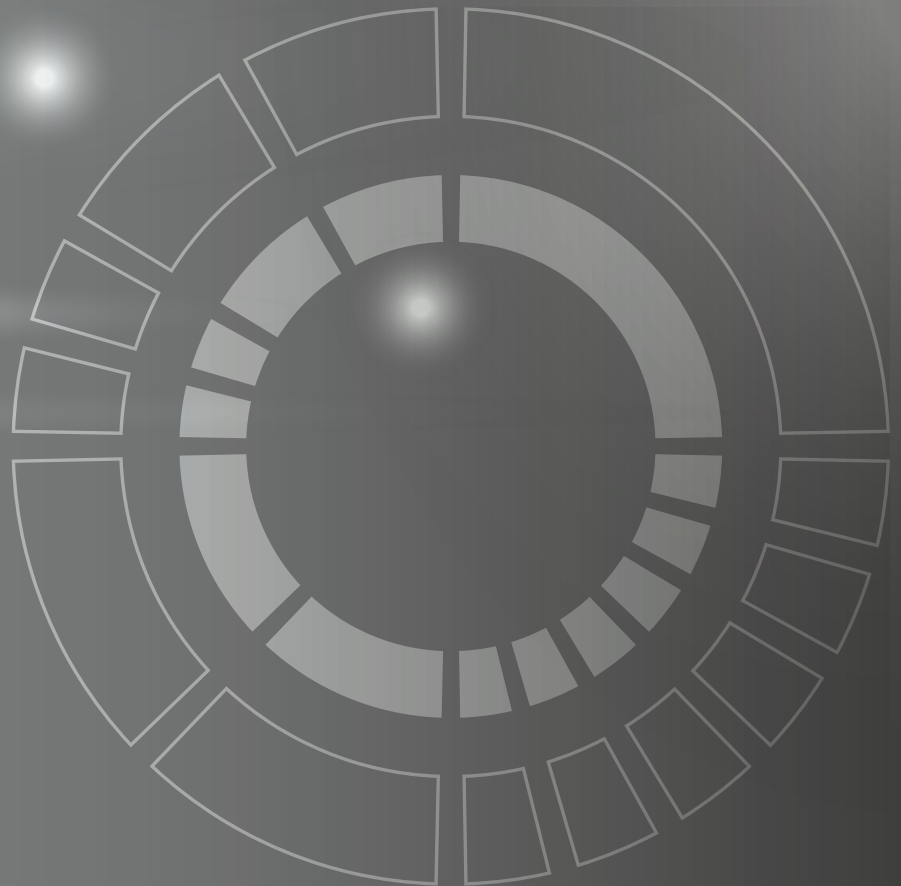

GOLDENBLAST

SAFE WATERBLAST TECHNOLOGY



TECHNICAL DATA																	
PART REF.	HOSE SIZE			R.O.D		O.D		MAX. W.P		BURST		MIN. BEND		WEIGHT		FITTINGS	
	DN	dash	inch	mm	inch	mm	inch	bar	psi	bar	psi	mm	inch	g/m	lb/ft	Std 1	Std 2
H10072010	10	-6	3/8"	17.6	0.69	20.2	0.80	750	10,870	1,875	27,190	180	7.09	756	0.51	BL+M01700-06	
H10072A12	12	-8	1/2"	20.4	0.80	23.0	0.91	750	10,870	1,875	27,190	220	8.66	905	0.61	BL+M01700-08	

KEY FEATURES

- Basic hose line for scale removing applications
- Compactness, lightness and flexibility
- Safety factor 2,5:1 (accepted world standard as specified by RMA-USA, BFPA-UK, DIN-Germany, ISO 7751)
- High abrasion resistant cover

APPLICATIONS & FLUIDS

- Waterblasting, scale removing applications using extreme high working pressures:
- Building and industrial sectors (roadworks, removal of concrete from reinforced concrete structures safeguarding metal components);
- Scale removal ships hulls in shipyard;
- Dust elimination
- Water, water soap, emulsions

CONTINUOUS SERVICE TEMPERATURE RANGE

-10 °C, 15 °F

70 °C, 158 °F

TUBE

Water resistant synthetic rubber

REINFORCEMENT

Four high tensile steel spirals

COVER

Synthetic rubber with high temperature, ozone and abrasion resistance

APPLICABLE SPECS

Manuli® Design, Australian Std. AS/NZS 4233.2

TYPE APPROVALS

CU-TR; MSHA

GOLDENBLAST/PLUS

SAFE WATERBLAST TECHNOLOGY



TECHNICAL DATA

PART REF.	HOSE SIZE			R.O.D		O.D		MAX. W.P		BURST		MIN. BEND		WEIGHT		FITTINGS	
	DN	dash	inch	mm	inch	mm	inch	bar	psi	bar	psi	mm	inch	g/m	lb/ft	Std 1	Std 2
H10066010	10	-6	3/8"	17.4	0.69	20.0	0.79	1,250	18,120	3,125	45,320	230	9.06	800	0.54	BL+M01700-06	
H10066A12	12	-8	1/2"	21.5	0.85	24.1	0.95	1,100	15,950	2,750	39,880	230	9.06	1,110	0.75	BL+M01700-08	
H10066019	19	-12	3/4"	29.0	1.14	32.0	1.26	1,000	14,500	2,500	36,250	250	9.84	1,730	1.16	BL+M01700-12	
H10066025	25	-16	1"	35.1	1.38	38.1	1.50	700	10,150	1,750	25,380	250	9.84	2,040	1.37	BL+M01500-16	

KEY FEATURES

- Hose line for waterblasting with pressures up to 1250 bar
- Compactness, lightness and flexibility
- Safety factor 2,5:1 (accepted world standard as specified by RMA-USA, BFPA-UK, DIN-Germany, ISO 7751)
- High abrasion resistance cover

APPLICATIONS & FLUIDS

- Waterblasting, scale removing applications using extreme high working pressures:
- Building and industrial sectors (roadworks, removal of concrete from reinforced concrete structures safeguarding metal components);
- Scale removal ships hulls in shipyard;
- Dust elimination
- Water, water soap, emulsions

CONTINUOUS SERVICE TEMPERATURE RANGE

-10 °C, 15 °F

70 °C, 158 °F

TUBE

Water resistant synthetic rubber

REINFORCEMENT

Four high tensile steel spirals

COVER

Synthetic rubber with very high temperature, ozone and abrasion resistance

APPLICABLE SPECS

Manuli® Design, Australian Std. AS/NZS 4233.2

TYPE APPROVALS

CU-TR; MSHA

GOLDENBLAST/SIX

SAFE WATERBLAST TECHNOLOGY



TECHNICAL DATA																	
PART REF.	HOSE SIZE			R.O.D		O.D		MAX. W.P		BURST		MIN. BEND		WEIGHT		FITTINGS	
	DN	dash	inch	mm	inch	mm	inch	bar	psi	bar	psi	mm	inch	g/m	lb/ft	Std 1	Std 2
H10067012	12	-8	1/2"	25.9	1.02	28.9	1.14	1,450	21,030	3,625	52,570	250	9.84	1,880	1.26	BL+M01800-08	
H10067019	19	-12	3/4"	32.4	1.28	35.4	1.39	1,350	19,580	3,375	48,950	280	11.02	2,630	1.77	BL+M01800-12	

KEY FEATURES

- Six wire spiral hose dedicated to severe applications with pressures up to 1450 bar
- Compactness, lightness and flexibility
- Safety factor 2,5:1 (accepted world standard as specified by RMA-USA, BFPA-UK, DIN-Germany, ISO 7751)
- High abrasion resistance cover

APPLICATIONS & FLUIDS

- Waterblasting, scale removing applications using extreme high working pressures:
- Building and industrial sectors (roadworks, removal of concrete from reinforced concrete structures safeguarding metal components);
- Scale removal ships hulls in shipyard;
- Dust elimination
- Water, water soap, emulsions

CONTINUOUS SERVICE TEMPERATURE RANGE

-10 °C, 15 °F

70 °C, 158 °F

TUBE

Water resistant synthetic rubber

REINFORCEMENT

Six high tensile steel spirals

COVER

Synthetic rubber with very high temperature, ozone and abrasion resistance

APPLICABLE SPECS

Manuli® Design, Australian Std. AS/NZS 4233.2

TYPE APPROVALS

CU-TR; MSHA

K-JET (BLACK)

PRESSURE WASH - BLACK VERSION



TECHNICAL DATA

PART REF.	HOSE SIZE			R.O.D		O.D		MAX. W.P		BURST		MIN. BEND		WEIGHT		FITTINGS	
	DN	dash	inch	mm	inch	mm	inch	bar	psi	bar	psi	mm	inch	g/m	lb/ft	Std 1	Std 2
H02003006	6	-4	1/4"	10.3	0.41	12.4	0.49	210	3,040	840	12,180	50	1.97	165	0.11	MF+M03300-04	OPF-04
H02003008	8	-5	5/16"	11.9	0.47	14.0	0.55	210	3,040	840	12,180	55	2.17	205	0.14	MF+M03300-05	
H02003010	10	-6	3/8"	14.5	0.57	16.5	0.65	210	3,040	840	12,180	65	2.56	300	0.20	MF+M03300-06	OPF-06
H02003012	12	-8	1/2"	17.7	0.70	19.9	0.78	210	3,040	840	12,180	90	3.54	410	0.28	MF+M03300-08	

KEY FEATURES

- Dust free smooth surface
- Indelible branding
- Compact structure: easy handling, reduced bend radius
- Good abrasion resistance
- Designed to meet IEC-2 (safety factor 4:1)

APPLICATIONS & FLUIDS

- Water-cleaning equipment, ideal for hobby and semi-professional machines
- Water, mineral oils, vegetable and rape seed oils, glycol and polyglycol based oils, synthetic ester based oils, oils in aqueous emulsion

CONTINUOUS SERVICE TEMPERATURE RANGE

-10 °C, 15 °F

135 °C, 275 °F

TUBE

Water resistant synthetic rubber

REINFORCEMENT

One high tensile steel braid

COVER

Environment resistant synthetic rubber

APPLICABLE SPECS

Manuli® Design

TYPE APPROVALS

CU-TR

K-JET (BLUE)

PRESSURE WASH - BLUE VERSION



TECHNICAL DATA																	
PART REF.	HOSE SIZE			R.O.D		O.D		MAX. W.P		BURST		MIN. BEND		WEIGHT		FITTINGS	
	DN	dash	inch	mm	inch	mm	inch	bar	psi	bar	psi	mm	inch	g/m	lb/ft	Std 1	Std 2
H02008006	6	-4	1/4"	10.3	0.41	12.4	0.49	210	3,040	840	12,180	50	1.97	165	0.11	MF+M03300-04	OPF-04
H02008008	8	-5	5/16"	11.9	0.47	14.0	0.55	210	3,040	840	12,180	55	2.17	200	0.13	MF+M03300-05	
H02008010	10	-6	3/8"	14.5	0.57	16.5	0.65	210	3,040	840	12,180	65	2.56	295	0.20	MF+M03300-06	OPF-06
H02008012	12	-8	1/2"	17.7	0.70	19.9	0.78	210	3,040	840	12,180	90	3.54	405	0.27	MF+M03300-08	

KEY FEATURES

- Dust free smooth surface
- Indelible branding
- Compact structure: easy handling, reduced bend radius
- Good abrasion resistance
- Designed to meet IEC-2 (safety factor 4:1)

APPLICATIONS & FLUIDS

- Water-cleaning equipment, ideal for hobby and semi-professional machines
- Water, mineral oils, vegetable and rape seed oils, glycol and polyglycol based oils, synthetic ester based oils, oils in aqueous emulsion

CONTINUOUS SERVICE TEMPERATURE RANGE

-10 °C, 15 °F
135 °C, 275 °F

TUBE

Water resistant synthetic rubber

REINFORCEMENT

One high tensile steel braid

COVER

Environment resistant synthetic rubber

APPLICABLE SPECS

Manuli® Design

TYPE APPROVALS

CU-TR

PROJET (BLACK)

PRESSURE WASH - BLACK VERSION



TECHNICAL DATA

PART REF.	HOSE SIZE			R.O.D		O.D		MAX. W.P		BURST		MIN. BEND		WEIGHT		FITTINGS	
	DN	dash	inch	mm	inch	mm	inch	bar	psi	bar	psi	mm	inch	g/m	lb/ft	Std 1	Std 2
H01A94006	6	-4	1/4"	11.3	0.44	13.1	0.52	400	5,800	1,600	23,200	45	1.77	280	0.19	MF+M00120-04	
H01A94008	8	-5	5/16"	12.9	0.51	14.6	0.57	400	5,800	1,600	23,200	100	3.94	315	0.21	MF+M00120-05	
H01A94010	10	-6	3/8"	16.7	0.66	18.5	0.73	400	5,800	1,600	23,200	130	5.12	520	0.35	MF+M00910-06	
H01A94012	12	-8	1/2"	19.8	0.78	21.8	0.86	350	5,070	1,400	20,300	178	7.01	660	0.44	MF+M00910-08	

KEY FEATURES

- Very high pressure resistance
- Lightness and flexibility
- Easy handling
- Good abrasion resistance
- Designed to meet IEC-2 (safety factor 4:1)
- Skive fitting solution for maximum robustness in professional long lasting applications

APPLICATIONS & FLUIDS

- Professional water-cleaning machines
- Water, mineral oils, vegetable and rape seed oils, glycol and polyglycol based oils, synthetic ester based oils, oils in aqueous emulsion

CONTINUOUS SERVICE TEMPERATURE RANGE

-10 °C, 15 °F

135 °C, 275 °F

TUBE

Water resistant synthetic rubber

REINFORCEMENT

Two high tensile steel braids

COVER

Environment resistant synthetic rubber

APPLICABLE SPECS

Manuli® Design

TYPE APPROVALS

CU-TR

PROJET (BLUE)

PRESSURE WASH - BLUE VERSION



TECHNICAL DATA																	
PART REF.	HOSE SIZE			R.O.D		O.D		MAX. W.P		BURST		MIN. BEND		WEIGHT		FITTINGS	
	DN	dash	inch	mm	inch	mm	inch	bar	psi	bar	psi	mm	inch	g/m	lb/ft	Std 1	Std 2
H01A95006	6	-4	1/4"	11.3	0.44	13.1	0.52	400	5,800	1,600	23,200	45	1.77	275	0.18	MF+M00120-04	
H01A95008	8	-5	5/16"	12.9	0.51	14.6	0.57	400	5,800	1,600	23,200	100	3.94	310	0.21	MF+M00120-05	
H01A95010	10	-6	3/8"	16.7	0.66	18.5	0.73	400	5,800	1,600	23,200	130	5.12	520	0.35	MF+M00910-06	
H01A95012	12	-8	1/2"	19.8	0.78	21.8	0.86	350	5,070	1,400	20,300	178	7.01	650	0.44	MF+M00910-08	

KEY FEATURES

- Very high pressure resistance
- Lightness and flexibility
- Easy handling
- Good abrasion resistance
- Designed to meet IEC-2 (safety factor 4:1)
- Skive fitting solution for maximum robustness in professional long lasting applications

APPLICATIONS & FLUIDS

- Professional water-cleaning machines
- Water, mineral oils, vegetable and rape seed oils, glycol and polyglycol based oils, synthetic ester based oils, oils in aqueous emulsion

CONTINUOUS SERVICE TEMPERATURE RANGE

-10 °C, 15 °F

135 °C, 275 °F

TUBE

Water resistant synthetic rubber

REINFORCEMENT

Two high tensile steel braids

COVER

Environment resistant synthetic rubber

APPLICABLE SPECS

Manuli® Design

TYPE APPROVALS

CU-TR

SUPERJET (BLACK)

PRESSURE WASH - BLACK VERSION



TECHNICAL DATA																	
PART REF.	HOSE SIZE			R.O.D		O.D		MAX. W.P		BURST		MIN. BEND		WEIGHT		FITTINGS	
	DN	dash	inch	mm	inch	mm	inch	bar	psi	bar	psi	mm	inch	g/m	lb/ft	Std 1	Std 2
H02001006	6	-4	1/4"	11.2	0.44	13.3	0.52	280	4,060	1,120	16,240	100	3.94	225	0.15	MF+M03400-04	OPF-04
H02001008	8	-5	5/16"	12.8	0.50	14.9	0.59	250	3,620	1,000	14,500	114	4.49	260	0.17	MF+M03400-05	OPF-05

KEY FEATURES

- Dust free smooth surface
- Indelible branding
- Easy handling
- Good abrasion resistance
- Designed to meet IEC-2 (safety factor 4:1)

APPLICATIONS & FLUIDS

- Water-cleaning equipment, ideal for hobby and semi-professional machines
- Water, mineral oils, vegetable and rape seed oils, glycol and polyglycol based oils, synthetic ester based oils, oils in aqueous emulsion

CONTINUOUS SERVICE TEMPERATURE RANGE

-10 °C, 15 °F

135 °C, 275 °F

TUBE

Water resistant synthetic rubber

REINFORCEMENT

One high tensile steel braid

COVER

Environment resistant synthetic rubber

APPLICABLE SPECS

Manuli® Design

TYPE APPROVALS

CU-TR

SUPERJET (BLUE)

PRESSURE WASH - BLUE VERSION



TECHNICAL DATA																	
PART REF.	HOSE SIZE			R.O.D		O.D		MAX. W.P		BURST		MIN. BEND		WEIGHT		FITTINGS	
	DN	dash	inch	mm	inch	mm	inch	bar	psi	bar	psi	mm	inch	g/m	lb/ft	Std 1	Std 2
H02002006	6	-4	1/4"	11.2	0.44	13.4	0.53	280	4,060	1,120	16,240	100	3.94	225	0.15	MF+M03400-04	OPF-04
H02002008	8	-5	5/16"	12.8	0.50	15.0	0.59	250	3,620	1,000	14,500	114	4.49	265	0.18	MF+M03400-05	OPF-05

KEY FEATURES

- Dust free smooth surface
- Indelible branding
- Easy handling
- Good abrasion resistance
- Designed to meet IEC-2 (safety factor 4:1)

APPLICATIONS & FLUIDS

- Water-cleaning equipment, ideal for hobby and semi-professional machines
- Water, mineral oils, vegetable and rape seed oils, glycol and polyglycol based oils, synthetic ester based oils, oils in aqueous emulsion

CONTINUOUS SERVICE TEMPERATURE RANGE

-10 °C, 15 °F

135 °C, 275 °F

TUBE

Water resistant synthetic rubber

REINFORCEMENT

One high tensile steel braid

COVER

Environment resistant synthetic rubber

APPLICABLE SPECS

Manuli® Design

TYPE APPROVALS

CU-TR

SUPERJET PLUS (BLACK)

PRESSURE WASH - BLACK VERSION



TECHNICAL DATA

PART REF.	HOSE SIZE			R.O.D		O.D		MAX. W.P		BURST		MIN. BEND		WEIGHT		FITTINGS	
	DN	dash	inch	mm	inch	mm	inch	bar	psi	bar	psi	mm	inch	g/m	lb/ft	Std 1	Std 2
H01A78006	6	-4	1/4"	12.7	0.50	14.7	0.58	400	5,800	1,600	23,200	55	2.17	370	0.25	MF+M03400-04	
H01A78008	8	-5	5/16"	14.3	0.56	16.3	0.64	350	5,070	1,400	20,300	60	2.36	410	0.28	MF+M03400-05	
H01A78010	10	-6	3/8"	15.0	0.59	16.8	0.66	330	4,780	1,320	19,140	65	2.56	390	0.26	MF+M03400-06	
H01A78012	12	-8	1/2"	18.5	0.73	20.3	0.80	275	3,980	1,100	15,950	80	3.15	480	0.32	MF+M03400-08	

KEY FEATURES

- Very high pressure resistance
- Lightness and flexibility
- Easy handling
- Good abrasion resistance
- Designed to meet IEC-2 (safety factor 4:1)

APPLICATIONS & FLUIDS

- Professional water-cleaning machines
- Water, mineral oils, vegetable and rape seed oils, glycol and polyglycol based oils, synthetic ester based oils, oils in aqueous emulsion

CONTINUOUS SERVICE TEMPERATURE RANGE

-10 °C, 15 °F

135 °C, 275 °F

TUBE

Water resistant synthetic rubber

REINFORCEMENT

Two high tensile steel braids

COVER

Environment resistant synthetic rubber

APPLICABLE SPECS

Manuli® Design

TYPE APPROVALS

CU-TR

HOSES 20

SUPERJET PLUS (BLUE)

PRESSURE WASH - BLUE VERSION



TECHNICAL DATA																	
PART REF.	HOSE SIZE			R.O.D		O.D		MAX. W.P		BURST		MIN. BEND		WEIGHT		FITTINGS	
	DN	dash	inch	mm	inch	mm	inch	bar	psi	bar	psi	mm	inch	g/m	lb/ft	Std 1	Std 2
H01A79006	6	-4	1/4"	12.7	0.50	14.7	0.58	400	5,800	1,600	23,200	55	2.17	365	0.25	MF+M03400-04	
H01A79008	8	-5	5/16"	14.3	0.56	16.3	0.64	350	5,070	1,400	20,300	60	2.36	405	0.27	MF+M03400-05	
H01A79010	10	-6	3/8"	15.0	0.59	16.8	0.66	330	4,780	1,320	19,140	65	2.56	390	0.26	MF+M03400-06	
H01A79012	12	-8	1/2"	18.5	0.73	20.3	0.80	275	3,980	1,100	15,950	80	3.15	475	0.32	MF+M03400-08	

KEY FEATURES

- Very high pressure resistance
- Lightness and flexibility
- Easy handling
- Good abrasion resistance
- Designed to meet IEC-2 (safety factor 4:1)

APPLICATIONS & FLUIDS

- Professional water-cleaning machines
- Water, mineral oils, vegetable and rape seed oils, glycol and polyglycol based oils, synthetic ester based oils, oils in aqueous emulsion

CONTINUOUS SERVICE TEMPERATURE RANGE

-10 °C, 15 °F

135 °C, 275 °F

TUBE

Water resistant synthetic rubber

REINFORCEMENT

Two high tensile steel braids

COVER

Environment resistant synthetic rubber

APPLICABLE SPECS

Manuli® Design

TYPE APPROVALS

CU-TR

FITTINGS

 **manuli**[®]
CONVEYORS LP & HP



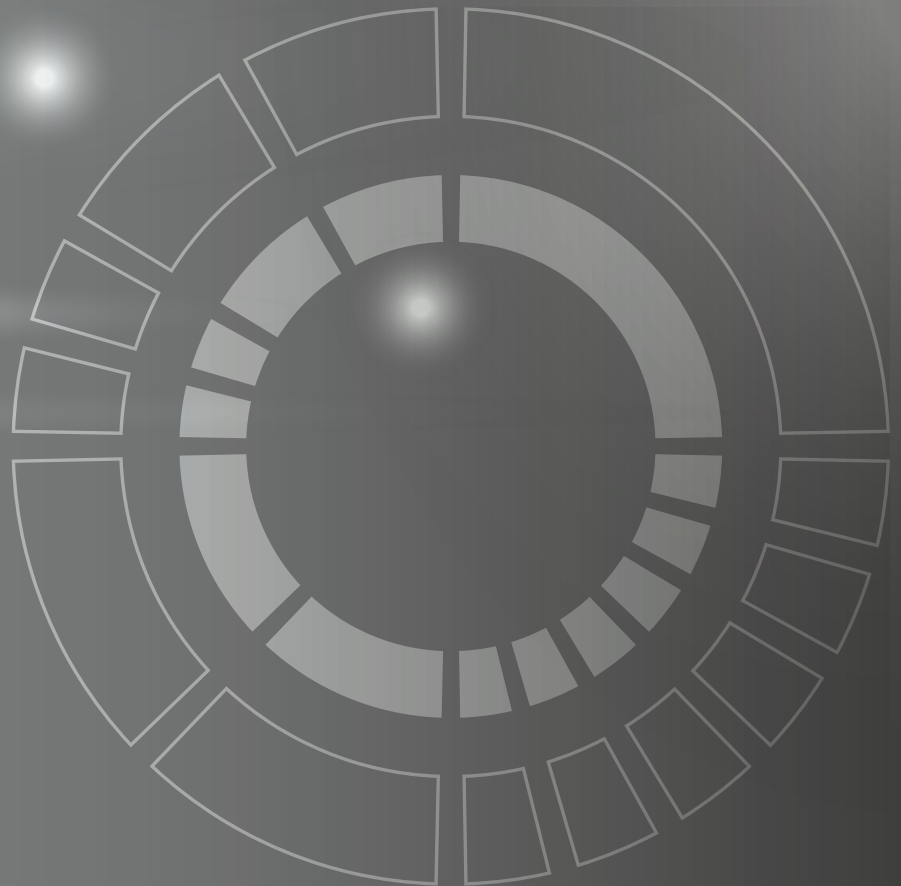

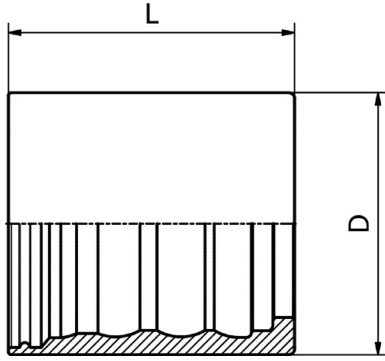

FERRULE

M00110/M00120/M00130

**SKIVE FERRULE
FOR WIRE BRAID HOSES**

PART. REF.	HOSE BORE			DIMENSIONS mm							
	DN	Dash	inch			D	L				
M00120-04	6	- 4	1/4"			19.5	28.0				
M00120-05	8	- 5	5/16"			20.0	28.6				

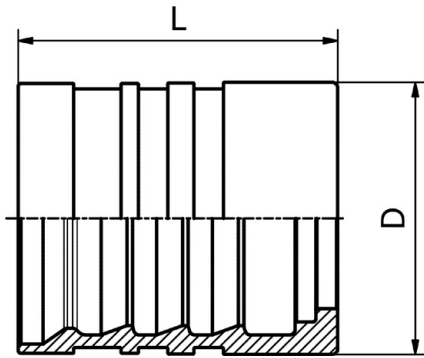

FERRULE

M00910/M00920/M00930

**SKIVE FERRULE
FOR WIRE BRAID
AND SPIRAL HOSES**

PART. REF.	HOSE BORE			DIMENSIONS mm							
	DN	Dash	inch			D	L				
M00910-06	10	- 6	3/8"			26.0	33.0				
M00910-08	12	- 8	1/2"			30.0	34.0				

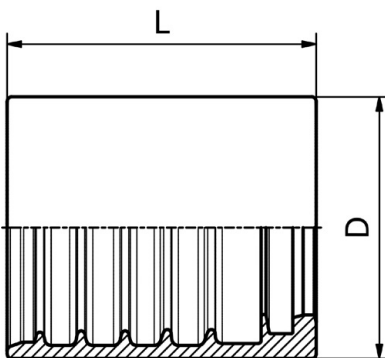

FERRULE

M03300

**NO-SKIVE FERRULE
FOR WIRE BRAID HOSES**

PART. REF.	HOSE BORE			DIMENSIONS mm							
	DN	Dash	inch			D	L				
M03300-04	6	- 4	1/4"			20.5	27.5				
M03300-05	8	- 5	5/16"			22.8	28.5				
M03300-06	10	- 6	3/8"			25.0	30.0				
M03300-08	12	- 8	1/2"			28.0	33.0				

FERRULE

M03400

**NO-SKIVE FERRULE
FOR WIRE BRAID HOSES**

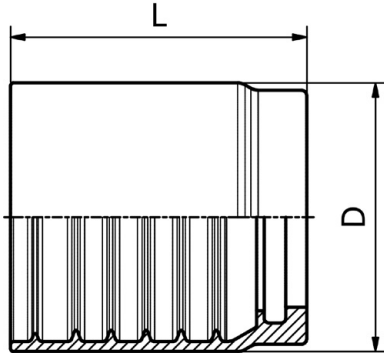

PART. REF.	HOSE BORE			DIMENSIONS mm							
	DN	Dash	inch			D	L				
M03400-04	6	- 4	1/4"			23.0	30.1				
M03400-05	8	- 5	5/16"			24.0	30.0				
M03400-06	10	- 6	3/8"			26.0	31.1				
M03400-08	12	- 8	1/2"			29.0	34.0				
M03400-10	16	- 10	5/8"			33.0	37.0				
M03400-12	19	- 12	3/4"			37.0	42.0				

CONNECTIONS - CLEANING

M24913

WASH CLEANER FEMALE

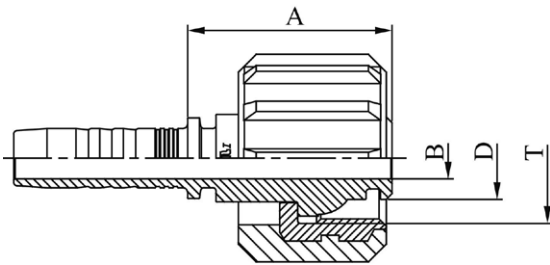

PART. REF.	HOSE BORE			Thread	DIMENSIONS mm						
	DN	Dash	inch	T	B	A	D				
M24913-04-22	6	- 4	1/4"	M 22X1,5	4.0	34.0	13.9				
M24913-05-22	8	- 5	5/16"	M 22X1,5	5.5	34.0	13.9				
M24913-06-22	10	- 6	3/8"	M 22X1,5	7.0	34.5	13.9				

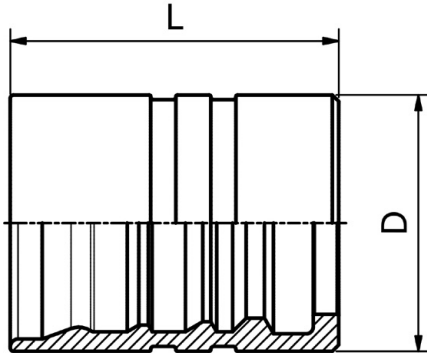

FERRULE

M01500

**DOUBLE SKIVE FERRULE
FOR HEAVY DUTY SPIRAL HOSES (4 PLY)**

PART. REF.	HOSE BORE			DIMENSIONS mm							
	DN	Dash	inch			D	L				
M01500-16	25	-16	1"			48.0	64.5				

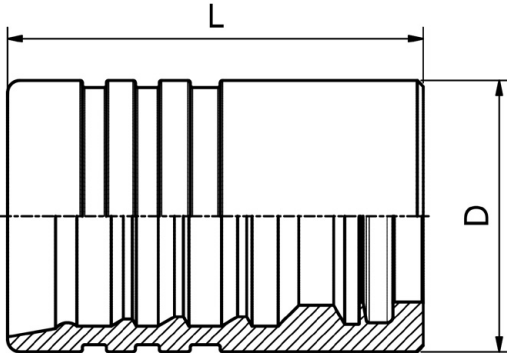

FERRULE - BLASTING

M01700

**DOUBLE SKIVE FERRULE
FOR EXTRA DUTY SPIRAL HOSES (4 PLY)**

PART. REF.	HOSE BORE			DIMENSIONS mm							
	DN	Dash	inch			D	L				
M01700-06	10	-6	3/8"			27.9	57.5				
M01700-08	12	-8	1/2"			34.0	65.0				
M01700-12	19	-12	3/4"			45.1	69.0				

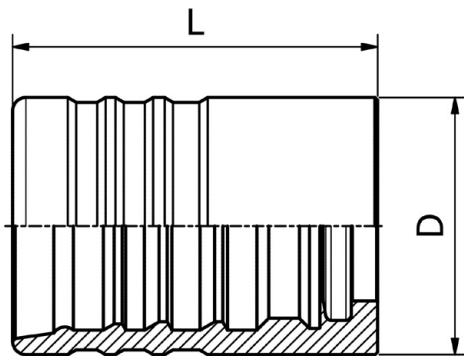

FERRULE - BLASTING

M01800

**DOUBLE SKIVE FERRULE
FOR EXTRA DUTY SPIRAL HOSES (6 PLY)**

PART. REF.	HOSE BORE			DIMENSIONS mm							
	DN	Dash	inch			D	L				
M01800-08	12	-8	1/2"			38.3	64.4				
M01800-12	19	-12	3/4"			48.6	69.0				

CONNECTIONS - BLASTING

M65514

**BSP FEMALE 60° CONE
(BS5200 - ISO 8434-6)**

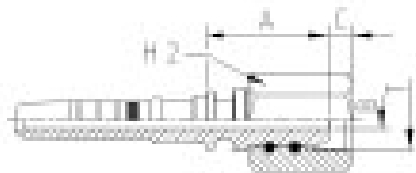

PART. REF.	HOSE BORE			THREAD	DIMENSIONS mm						
	DN	Dash	inch	T	B	A	C	H2			
M65514-06-06	10	-6	3/8"	3/8" - 19	4.8	34.5	6.0	24.0			
M65514-08-08	12	-8	1/2"	1/2" - 14	9.0	37.0	6.5	30.0			
M65514-12-12	19	-12	3/4"	3/4" - 14	12.0	43.0	8.7	36.0			

The BLASTLOCK fittings have to be used with the GOLDENBLAST hoses only, that are suggested for waterblasting applications. For hydraulic applications please refer to the dedicated fittings (ILP).

"B" dimension does not comply with: BS5200 and ISO8434-6 spec.

CONNECTIONS - BLASTING

M57810 (DN 16: M52810)

**NPTF MALE 60° CONE SEAT
- SAE J516/J514**

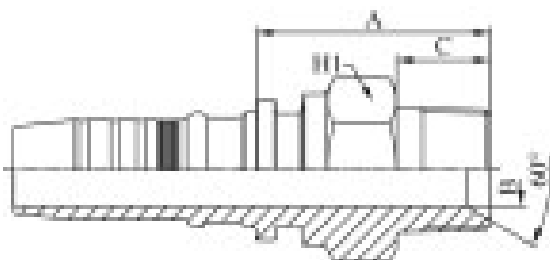

PART. REF.	HOSE BORE			THREAD	DIMENSIONS mm						
	DN	Dash	inch	T	B	A	C	H1			
M57810-06-06	10	-6	3/8"	3/8" - 18	8.5	38.0	15.5	22.0			
M57810-08-08	12	-8	1/2"	1/2" - 14	10.0	44.5	21.0	27.0			
M57810-12-12	19	-12	3/4"	3/4" - 14	15.0	49.5	21.0	32.0			
M57810-16-16	25	-16	1"	1" - 11	19.5	55.0	24.2	41.0			

The BLASTLOCK fittings have to be used with the GOLDENBLAST hoses only, that are suggested for waterblasting applications. For hydraulic applications please refer to the dedicated fittings (ILP).

M66613

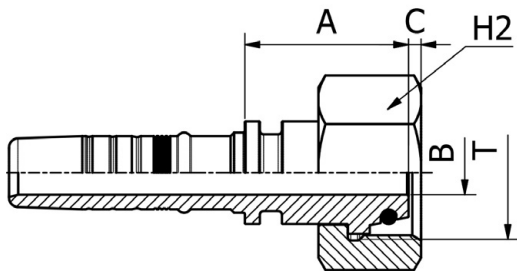

**METRIC O-RING FEMALE 24° CONE HEAVY DUTY
- DIN 20066/ISO
12151-2 (SLIP-ON NUT)**

PART. REF.	HOSE BORE			THREAD	PIPE	DIMENSIONS mm						
	DN	Dash	inch	T	mm	B	A	C	H2			
M66613-06-22	10	-6	3/8"	M 22 X 1.5	14	4.8	32.0	3.5	27.0			
M66613-06-24	10	-6	3/8"	M 24 X 1.5	16	6.3	34.0	4.0	32.0			
M66613-08-24	12	-8	1/2"	M 24 X 1.5	16	9.0	35.5	4.0	32.0			
M66613-12-36	19	-12	3/4"	M 36 X 2	25	12.0	44.5	3.4	46.0			
M66613-16-42	25	-16	1"	M 42 X 2	30	19.5	43.5	5.3	50.0			

The BLASTLOCK fittings have to be used with the GOLDENBLAST hoses only, that are suggested for waterblasting applications. For hydraulic applications please refer to the dedicated fittings (ILP).



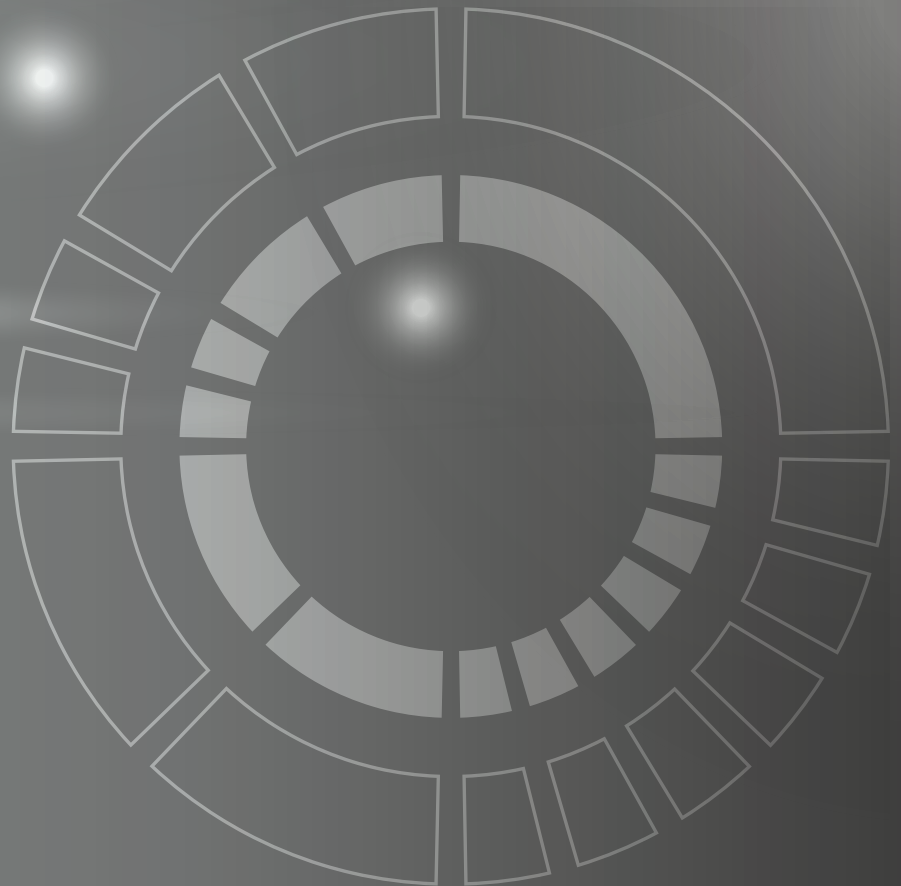

ASSEMBLING INSTRUCTIONS



The following assembling instructions are strongly recommended for heavy-duty applications

The crimping operation to apply BLASTLOCK fittings must be carried out with proper high performance crimping/assembling machines, with a crimping force higher than 2,800-3,000 kN, and approved by Manuli Hydraulics. This is in order to guarantee the optimum coupling assembly deformations and correct hose gripping.

It is recommended that the detailed assembling instructions are followed. These are supplied by Manuli Hydraulics to customers, assemblers and operators using the integrated package, GOLDENBLAST hose & BLASTLOCK fittings.

Each assembly must be pressure tested at the pressure level required by the reference specifications (e.g. EN 1829-2 requirement is 1.5 times the WP for minimum 30 seconds) and taking into consideration all safety implications.

Specialised personnel are recommended for the assembling operation of BLASTLOCK fittings.

PART REF.	THREAD SIZE	OR SUPPLIED (NBR 90 Sha)	TIGHTENING TORQUE (Nm)
M66613-6-22	M 22 x 1.5	10 x 2	70
M66613-08-24	M 24 x 1.5	12 x 2	100
M66613-12-36	M 36 x 2	20.3 x 2.4	190
M66613-16-42	M 42 x 2	25.3 x 2.4	220

RECOMMENDATIONS

Please see the following recommendations for the safe and correct use of the Manuli Goldenblast product line:

- **Don't mix and match:** MRI highly recommends the use of its integrated waterblasting package. The use of alternative hose or fittings can result in poor quality and reliability of the assembly.
- In line with international regulations, **all** waterblasting assemblies should be **tested to 150% of the indicated maximum static working pressure** before using.
- If waterblasting assemblies are used at a pressure exceeding the maximum working pressure indicated, the assemblies structure can cause an over-stressed situation. For the same reason **pulsating pressure** situations also need to be avoided.
- **Relief valves** should be used to preserve waterblasting equipment and hose assemblies.
- When **safety devices** are applied to prevent fitting blow-off, hose elongation and contraction needs to be taken in consideration. Under pressure, the hose length can vary between -4% to +2%.
- **Waterblasting assemblies should never be used in "hang down" positions.** These conditions can cause hose reinforcement restriction to contraction/elongation and over-stress fittings when supporting the weight of the hanging hose.
- Strictly avoid applying any **external force** on the hose assembly, such as axial tension, twisting, kinking or crushing.
- **Temperature** influences the resistance to leakage. Working temperature should be maintained below 70°C.
- Hose assemblies need to be replaced in case of damage, such as:
 - hose cover abrasion, cuts, chemical attack, corrosion
 - reinforcement crushing or twisting
- **High pressure water must always be considered as extremely dangerous.** Anyone handling waterblasting equipment should wear proper protective clothing, boots and eye protection.



www.manuli-hydraulics.com/conveyors



Global Marketing Office
Email: marketing@manuli-hydraulics.com

© Copyright 2021 Manuli Hydraulics. All rights reserved.
All product names are either trademarks or registered trademarks of
Manuli Hydraulics or Manuli Rubber Industries unless otherwise stated.