

ASSEMBLY MACHINES

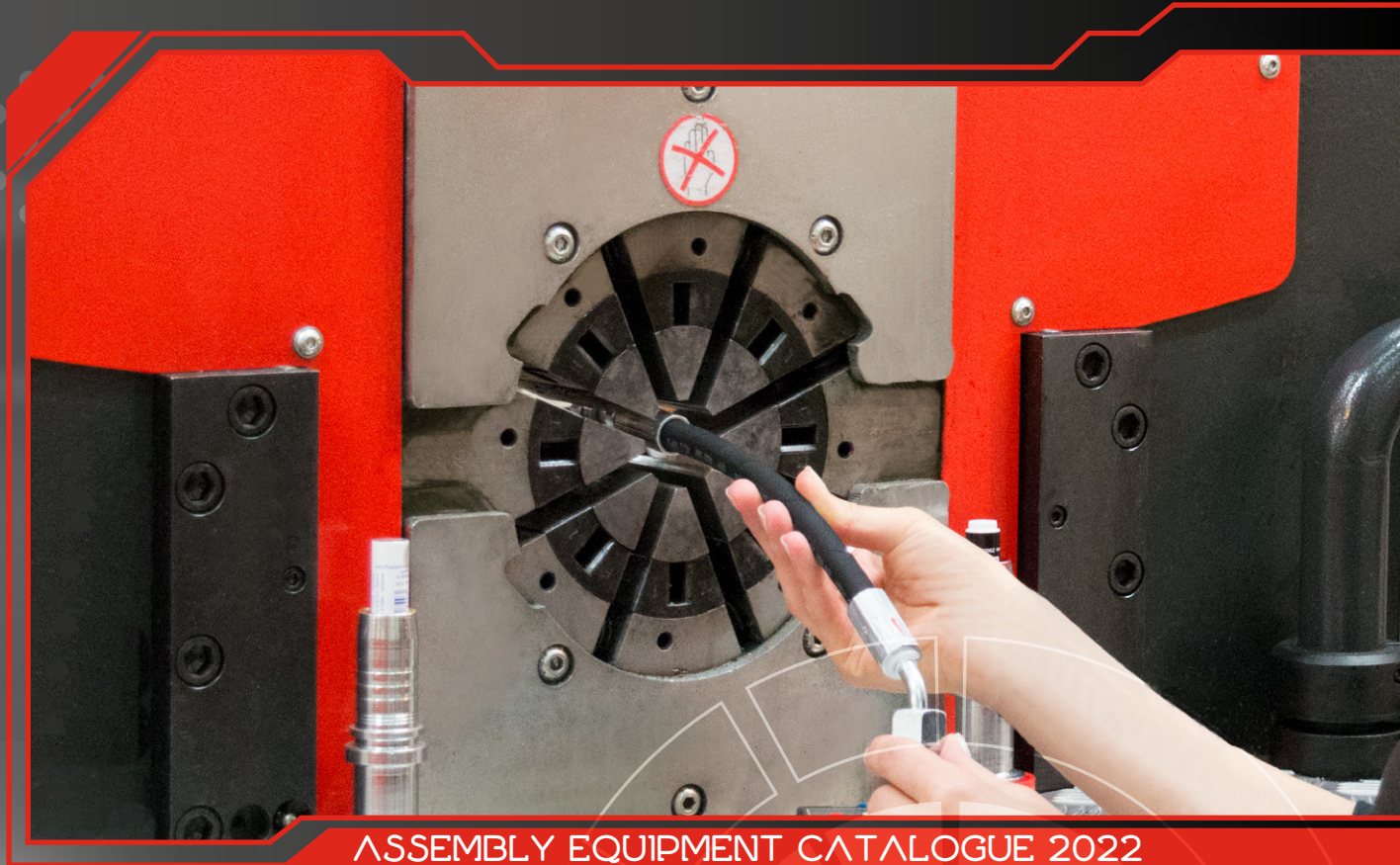

ASSEMBLY EQUIPMENT CATALOGUE 2022

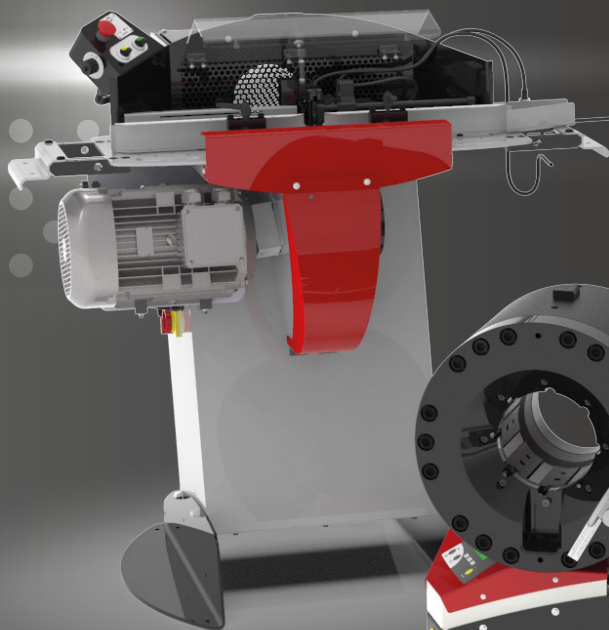

 **manuli**[®]
EQUIPMENT

As the world's leading supplier of integrated hydraulic connector solutions, Manuli Hydraulics has become known for the quality and reliability of its benchtop equipment and crimping solutions. With an established equipment range for portable, benchtop and OEM level assembly equipment, Manuli Hydraulics has worked closely with customers to ensure their equipment meets the toughest demands of the hydraulic hose industry.

Now, with the establishment of the Manuli Equipment unit, we have expanded our range of assembly machines to include dedicated solutions for industrial and automotive hose assembly. This expanded range allows us to support an even wider range of applications and industries with first-class assembly equipment solutions.

With offices in North America, Asia and Russia, along with our design and manufacturing facilities in Europe, Manuli Equipment has established a global network to support our customers with prompt service and support for all equipment.

Manuli Equipment continues to innovate in order to serve an ever-expanding market with reliable, hard working equipment and unbeatable service. When you decide on your next line of equipment, look for the Manuli brand to ensure you have the best so you can make the best.

All Manuli Equipment assembly machines undergo a rigorous product development process and are subject to extensive testing in both laboratory and field environments.



CONTENTS

Cutting Machines.....	1
Skiving Machines.....	9
Insert Pushing Machines.....	15
Marking Machines.....	17
Complementary Products.....	19
Crimping Machines.....	21
Test Benches.....	47
Industrial Machines.....	49
Available Die Sets.....	63



FIELD SERVICE & MOBILE WORKSHOP 12V/24V

A compact and robust line up to 2", perfect for on-site repair. The hand crimper, H Crimp 80, offers accessibility to all sites. A complete 12V line delivers hose assembly quality equal to the one obtained in a workshop.

MHP 80 (Pg.21)

Capacity: 1" 2 WB
Compact
Lightweight
Easy to use
Balanced design
Dual stage pump

MH SKY (Pg.9)

Capacity: 2"
Economic
Simple
Compact
Robust
Plug n skive system

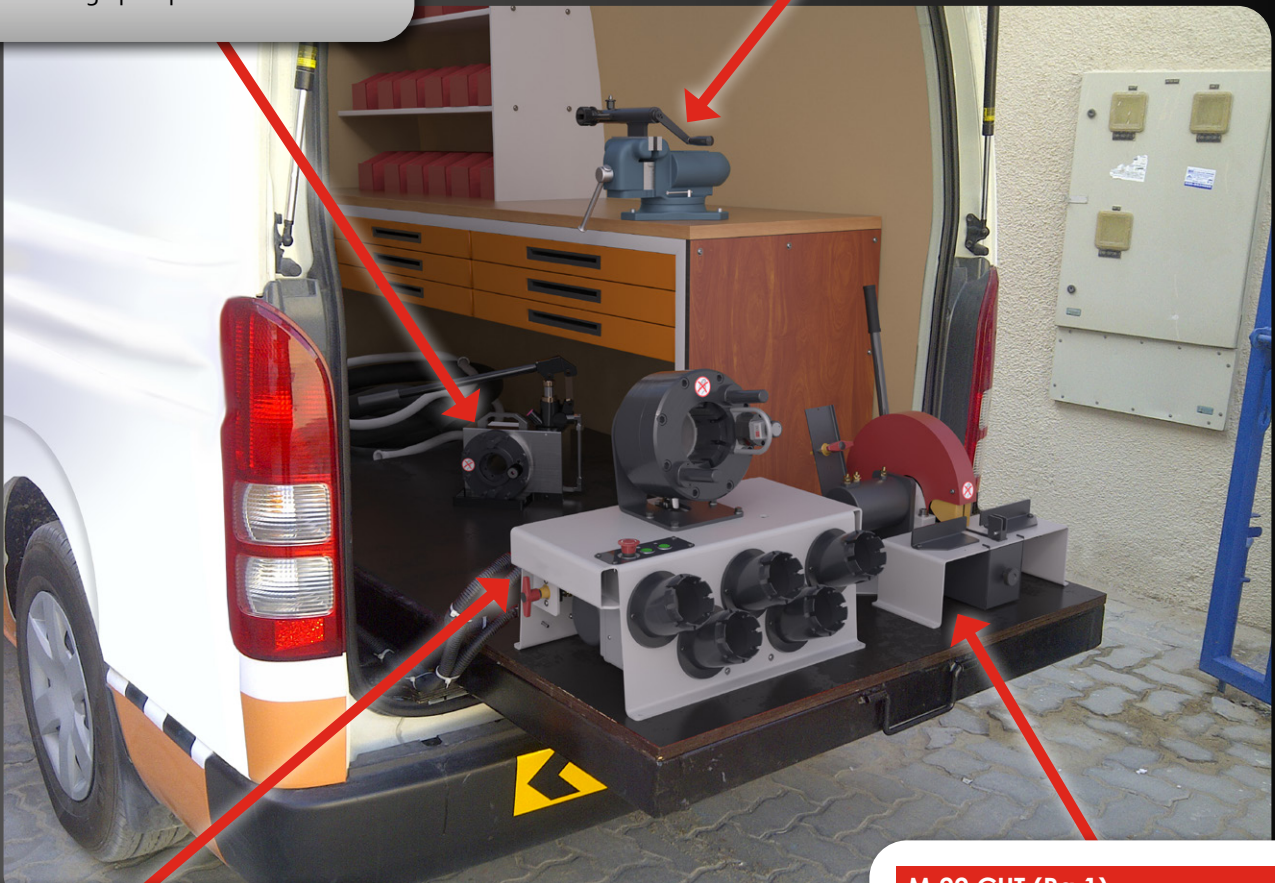

MV 137 (Pg.30)

Capacity: 1 1/4" WS
Robust and compact design
Lightweight
High crimping speed
Suitable also for 90° elbow fittings
Cylinder protection
Remote head mounting option possible

M 22 CUT (Pg.1)

Capacity: 1 1/4"
Smooth bending system
90° cut
Clean cut
Scalloped blade
Dust collector included
Multiple voltage options

EXPERT SERVICE LINE

A result of our collaboration with OEM assemblers and hose manufacturers, our expert workshop combines power, reliability, speed, openness and comfort. Manuli Equipment is now one of the most innovative manufacturer in machines dedicated to OEM, providing (for instance) the Safe Crimp System which guarantees a constant control of hose assemblies.

M 90 CUT (Pg.7)

- Capacity: 3" 6WS
- Very powerful
- Heavy duty for difficult cuts
- Hydraulic bending
- Brake motor
- Electronic soft start

M 300 SKY (Pg.11)

- Capacity: 3"
- Plug'n skive system
- Large dust collector
- Robust & easily adjustable knife for quick and easy changeover
- Suitable for high volume production
- 2-way rotation



M 1500 INS (Pg.15)

- Capacity: all hydraulic hoses from 3/4" up to 2" Interlock
- Compact
- Sturdy
- Powerful
- Hydro pneumatic power pack

MS 480 (Pg.37)

- Capacity: 6" WS
- High crimp force
- Large opening
- Safe Crimp System (SCS) control
- Wide family of dies for industrial hoses
- Long master dies
- Robust
- Low noise level
- Easy die set-up with ergonomic gun

XXL WORKSHOP

A workshop developed on a complete range of Industrial crimpers combining power, openness, ergonomics and solutions for handling large diameters. This workshop increases your potential of opportunities. It allows you to prospect many and various markets and thus amortize your investment quickly. Our knowledge of the activity constraints led us to offer ergonomic solutions adapted to the handling of large diameters.



MS 800 (Pg.38)

- Capacity: 4" 4WS / 3" 6WS / 8" Industrial
- Designed for heavy duty large bore hydraulic hoses
- High power and speed
- Ergonomically designed for large bore hoses
- Safe Crimp System (SCS) for maximum reliability during the crimping process
- Large opening up to 8"
- Long master dies
- Very high crimping force

Manuli Equipment is always on the lookout for ways to improve both the efficiency and the quality of new and existing production operations.

As a market leader in assembly machines, we wanted to offer new crimping machines to improve the operator's comfort, giving more flexibility when assembling hoses. This led to the creation of the new EVO crimping machines.

These machines combine the robustness required for harsh environments with the reliability needed for busy workshops. Their compact and ergonomic design, along with the ease of set up and maintenance, make them suitable for a variety of applications.

This extensive range is highly adaptable, with various options available allowing users to customise their machine according to their specific needs.

- Extensive range for both industrial and hydraulic hoses
- 137, 240, 350 and 420 tonnes variants
- From 3/16 up to 4" hose diameter
- 4 kW or 5,5 kW motor for 3Ph

- Compact and ergonomic design
- Easy set up
- Various options available depending on our customers' needs and workshops

- SC panel - Smart Control panel. Daily counter. Semi-automatic opening
- Bluetooth connection 
- SCE panel - electronic micrometer with the ability to save up to 75 configurations and 25 die sets
- Caliper connected and numerical display of the crimping range on SCE
- SCS panel - Safe Crimp System with caliper option

- Robust
- Ease of maintenance (foam pad dust collector)
- Compatibility with all tensions (different frequencies)

M 22 CUT / MV 22 CUT

STARTER WORKSHOP
BENCHTOP

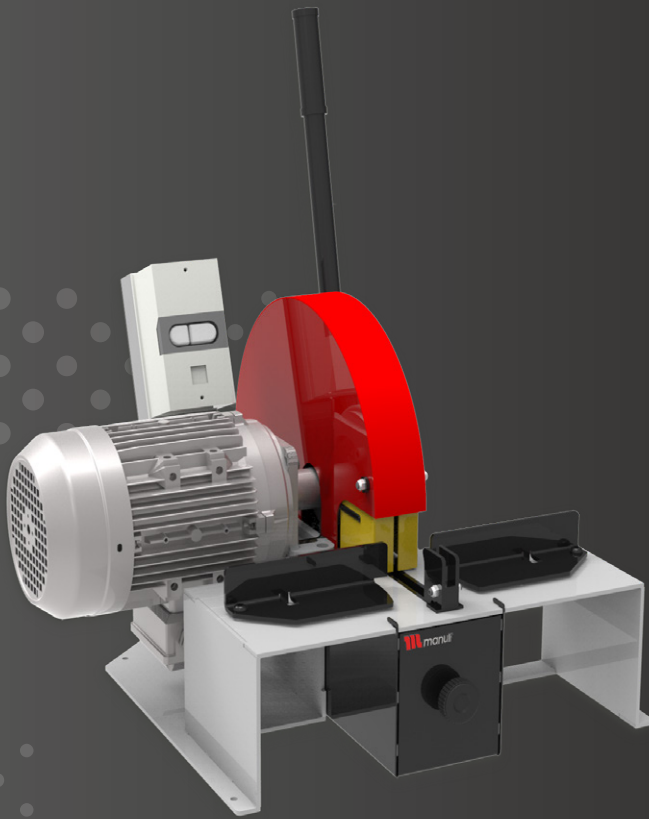

KEY FEATURES

- Smooth bending system
- 90° cut
- Clean cut
- Scalloped blade
- Dust collector included
- Multiple voltage options

CUTTING MACHINES
1

STANDARD

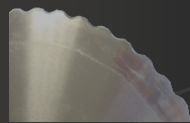

Scalloped Blade

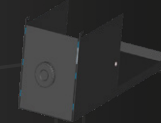

Dust Collector

TECHNICAL SPECIFICATIONS

CAPACITY

2wb: 1¼" max.

4ws: 1¼" max.

ROTATION SPEED

3000 rpm

SCALLOPED BLADE DIAMETER

254 mm (10") included

MAX HOSE OD.

50 mm (1.969")

MOTOR

2.2 kW

VOLTAGES

220/240 V, 3Ph, 50 Hz

380/415 V, 3Ph, 50 Hz

208/240 V, 3Ph, 60 Hz

380/415 V, 3Ph, 60 Hz

12/24 V also available upon request

DIMENSIONS

630 x 485 x 650 mm

(25 x 19 x 26 ")

PACKAGING

800 x 600 x 830 mm

(31 x 24 x 33")

NET WEIGHT

42 kg (93 lb)

GROSS WEIGHT

55 kg (121 lb)

TECHNICAL FEATURES

Dimensions van type machine:

488 x 630 x 650 mm
(19.2 x 24.8 x 25.6");
38 kg (84 lb)

Single-phase S3 25% service factor

OPTIONAL



Battery & Charger



Slotted Blade

M 30 CUT E

STARTER & PROFESSIONAL WORKSHOP
BENCHTOP CUTTING MACHINE, OPTIONAL SKIVING

CUTTING MACHINES
2

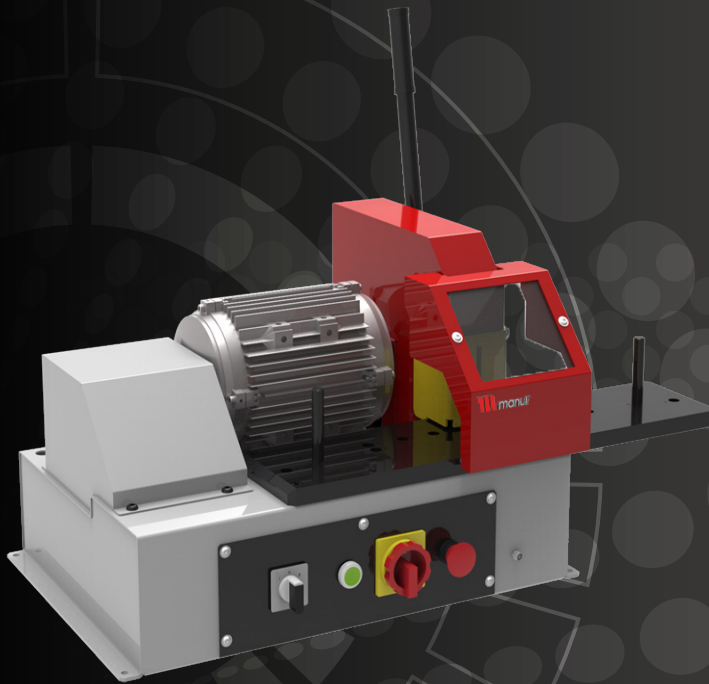

KEY FEATURES

- Compact design
- Easy and safe to use
- Versatile, scalloped blade for high performance and efficient cutting with minimal smoke

STANDARD



Scalloped Blade



Dust Collector

TECHNICAL SPECIFICATIONS

CAPACITY

- 2wb: 2" max.
- 4ws: 2" max.
- 6ws: 1¼" max.
- Industrial: 2" max.

ROTATION SPEED

3000 rpm

SCALLOPED BLADE DIAMETER

300 mm (11.8")

MAX HOSE OD.

85 mm (3.346")

MOTOR

2.2 kW

VOLTAGES

- 220/240 V, 3Ph, 50 Hz
- 380/415 V, 3Ph, 50 Hz
- 208/240 V, 3Ph, 60 Hz
- 380/415 V, 3Ph, 60 Hz

DIMENSIONS

835 x 545 x 640 mm
(33 x 21 x 25")

PACKAGING

1170 x 770 x 1100 mm
(46 x 30 x 43")

NET WEIGHT

75 kg (165 lb)

GROSS WEIGHT

90 kg (198 lb)

OPTIONAL

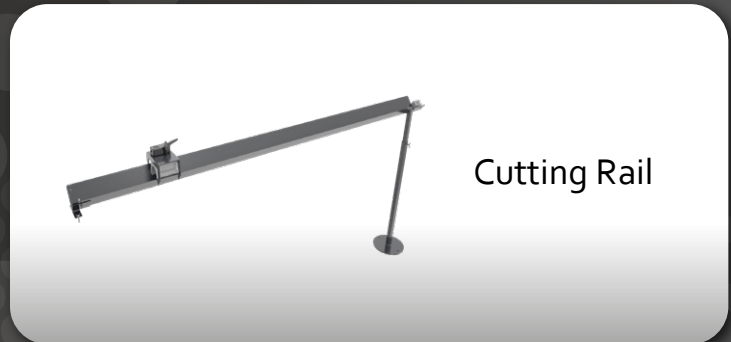

Cutting Rail

M 30 CUT L

STARTER & PROFESSIONAL WORKSHOP
STAND TYPE CUTTING MACHINE



KEY FEATURES

- Compact design
- Easy and safe to use
- Versatile, scalloped blade for high performance and efficient cutting with minimal smoke
- Ergonomic, easy to clean
- Integrated dust collector

STANDARD

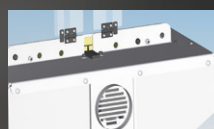

Smoke Suction Connector



2 Dust Collectors



Scalloped Blade

TECHNICAL SPECIFICATIONS

CAPACITY

- 2wb: 2" max.
- 4ws: 2" max.
- 6ws: 1¼" max.
- Industrial: 2"

ROTATION SPEED

3000 rpm

SCALLOPED BLADE DIAMETER

254 mm (10")

MAX HOSE OD.

85 mm (3.34")

MOTOR

3.0 kW

VOLTAGES

- 220/240 V, 3Ph, 50 Hz
- 380/415 V, 3Ph, 50 Hz
- 208/240 V, 3Ph, 60 Hz
- 380/415 V, 3Ph, 60 Hz

DIMENSIONS

765 x 500 x 1150 mm
(30 x 20 x 45")

PACKAGING

800 x 600 x 1200 mm
(32 x 24 x 47")

NET WEIGHT

92 kg (203 lb)

GROSS WEIGHT

120 kg (265 lb)

TECHNICAL FEATURES

Single-phase S3 25% service factor

OPTIONAL

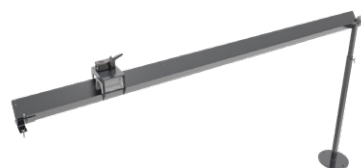

Cutting Rail



Slotted Blade

M 30 CUT & SKIVE

STARTER & PROFESSIONAL WORKSHOP
BENCHTOP, INTEGRATED CUTTING & SKIVING

CUTTING
MACHINES
4



KEY FEATURES

- Compact design
- Two operations in one machine
- Easy and safe to use
- Versatile, scalloped blade for high performance and efficient cutting with minimal smoke
- Dust free skive operation (drawers for dust collection)
- Electronic brake

STANDARD



Scalloped Blade



2 Dust Collectors

TECHNICAL SPECIFICATIONS

CAPACITY

- 2wb: 2" max.
- 4ws: 2" max.
- 6ws: 1 1/4" max.
- Industrial: 2" max.

VOLTAGES

- 220/240 V, 3Ph, 50 Hz
- 380/415 V, 3Ph, 50 Hz
- 208/240 V, 3Ph, 60 Hz
- 380/415 V, 3Ph, 60 Hz

ROTATION SPEED (CUT)

3000 rpm

DIMENSIONS

835 x 545 x 640 mm
(33 x 21 x 25")

ROTATION SPEED (SKIVE)

200 rpm

PACKAGING

1170 x 770 x 1100 mm

SCALLOPED BLADE DIAMETER

300 mm (11.8")

46 x 30 x 43"

MAX HOSE OD.

85 mm (3.34")

NET WEIGHT

85 kg (187 lb)

MOTOR

2.2 kW

GROSS WEIGHT

100 kg (220 lb)

TECHNICAL FEATURES

Skiving tools for External Skiving (ESE) and for Internal Skiving (IS) to be ordered separately

OPTIONAL



Cutting Rail

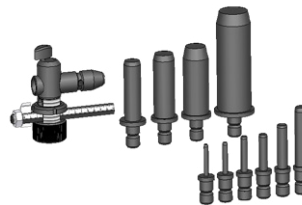

Tool Kit ESE



Tool Kit IS

M 55 CUT

FULL SERVICE WORKSHOP, STARTER PRODUCTION UNITS
STAND TYPE CUTTING MACHINE



STANDARD



Control Panel

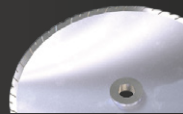

Slotted Blade



Feeding Guide



Dust Collector

KEY FEATURES

- Versatile, slotted blade for high performance smoke free cutting
- Ergonomic and functional design
- Double foot pedal system
- Safety cover and feeding guides for hose (easy and fast cutting operation)
- Digital counter for maintenance assistance
- Adjustable speed for cutting on pneumatic version

TECHNICAL SPECIFICATIONS

CAPACITY

2wb: 2" max.

4ws: 2" max.

6ws: 2" max.

Industrial: 2"

ROTATION SPEED

3000 rpm

SLOTTED BLADE DIAMETER

400 mm (15.7")

MAX HOSE OD.

80 mm (3.15")

MOTOR

7.5 kW

VOLTAGES

220/240 V, 3Ph, 50 Hz

380/415 V, 3Ph, 50 Hz

208/240 V, 3Ph, 60 Hz

380/415 V, 3Ph, 60 Hz

DIMENSIONS

1140 x 1000 x 1280 mm

(45 x 39 x 50")

PACKAGING

1600 x 1200 x 1600 mm

(63 x 47 x 63")

NET WEIGHT

240 kg (529 lb)

GROSS WEIGHT

280 kg (617 lb)

TECHNICAL FEATURES

Diameter of the suction connection: 150 mm (6")

Options: Pneumatic bending system, scalloped blade

OPTIONAL



Cutting Rail



DV 32



OEM Decoiler (Optional Electrical Version)



Smoke Extractor

M 75 CUT

EXPERT SERVICE LINE
STAND TYPE CUTTING MACHINE

CUTTING MACHINES
6



KEY FEATURES

- Very powerful
- Heavy duty for difficult cuts
- Robust for extreme cuts
- New design:
 - *Easy maintenance*
 - *Efficient smoke extraction*
- Brake motor (option)
- Manual & Pneumatic versions available
- Option for industrial hose:
 - *540mm blade for hoses with 150mm max. OD*

STANDARD

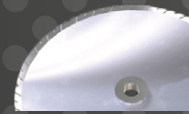

Slotted Blade

TECHNICAL SPECIFICATIONS

CAPACITY

2wb: 3" max.
4ws: 2" max.
6ws: 2" max.

ROTATION SPEED

3000 rpm

SLOTTED BLADE DIAMETER

520 mm (20.5") included

MAX HOSE OD.

125 mm (5")

MOTOR

7.5 kW

VOLTAGES

220/240 V, 3Ph, 50 Hz
380/415 V, 3Ph, 50 Hz
208/240 V, 3Ph, 60 Hz
380/415 V, 3Ph, 60 Hz

DIMENSIONS

910 x 820 x 1280 mm
(36 x 32 x 50")

NET WEIGHT

215 kg (474 lb)

TECHNICAL FEATURES

Diameter of suction connection: 110 mm (4.33")

Optional tool: Brake motor, slotted disc

OPTIONAL



Cutting Rail



DV 32



OEM Decoiler (Optional Electrical Version)



Smoke Extractor

M 90 CUT

EXPERT SERVICE LINE
STAND TYPE CUTTING MACHINE

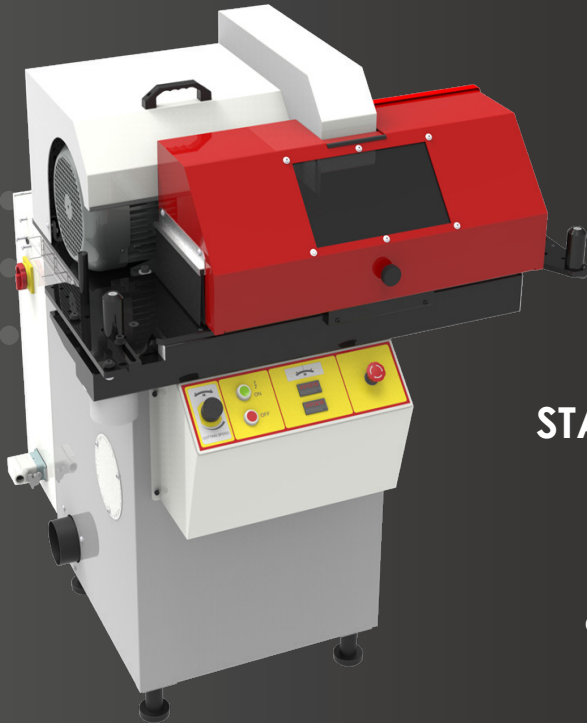

KEY FEATURES

- Very powerful
- Heavy duty for difficult cuts
- Hydraulic bending
- Brake motor
- Electronic soft start
- Smoke suction integrated in cutting table

STANDARD



CME Electrical Foot Switch



Production Counters

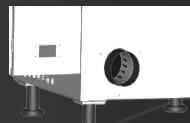

Smoke Suction Connector

TECHNICAL SPECIFICATIONS

CAPACITY

- 2wb: 3½" max.
- 4ws: 3½" max.
- 6ws: 3" max.

ROTATION SPEED

3000 rpm

SLOTTED BLADE DIAMETER

520 mm (20.5") included

MAX HOSE OD.

125 mm (5")

MOTOR

9.0 kW

TECHNICAL FEATURES

- Diameter of suction connection: 110 mm (4.33")
- Standard tool: Hydraulic bending, brake motor

VOLTAGES

- 220/240 V, 3Ph, 50 Hz
- 380/415 V, 3Ph, 50 Hz
- 208/240 V, 3Ph, 60 Hz
- 380/415 V, 3Ph, 60 Hz

DIMENSIONS

1000 x 1060 x 1350 mm
(39 x 42 x 53")

NET WEIGHT

260 kg (573 lb)

OPTIONAL



Cutting Rail



DV 32



OEM Decoiler (Optional Electrical Version)



Smoke Extractor

ACCESSORIES AND TOOLS

CUTTING DISCS

SCALLOPED BLADE TYPE

The scalloped blade is suitable for all hose types. It is able to reach a high quality of cutting surface and is the standard on 254 and 300 mm blades.

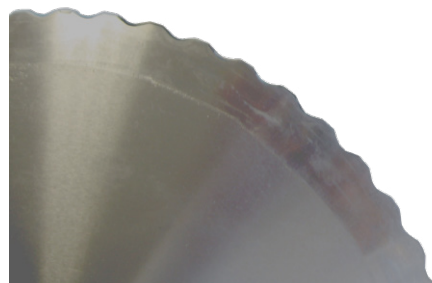

SLOTTED BLADE TYPE

The slotted blade is recommended for cutting standard and heavy duty hoses. It is ideal for continuous service, as the blade profile has been optimised to maintain a low temperature on the cutting edge. This blade provides an extended operational life of up to 2 times that of the previous blade, and is the standard on 400 and 520 mm blades. 254 mm blade available as option on M22 CUT and M30 CUT L.

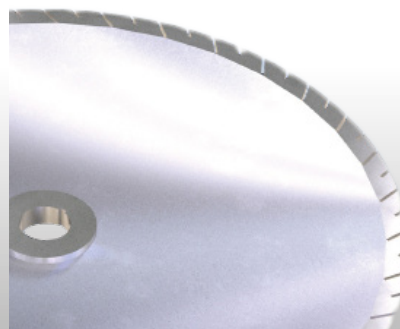

BRAKE MOTOR

The brake motor is a device which stops the disc immediately when the stop button is pushed.

PNEUMATIC BENDING

Available on M 75 CUT and M 55 CUT.

Pneumatic bending facilitates cutting, as the operator does not have to force the hose on the blade. The pneumatic system, activated by a foot switch, offers hands free operation. This is the same principle for the hydraulic bending on M 90 CUT.

MH SKY

FIELD SERVICE & MOBILE WORKSHOP
MANUAL, PORTABLE SKIVING TOOL

KEY FEATURES

- Portable, lightweight
- Economic
- Simple
- Compact
- Robust
- Plug-in skive system

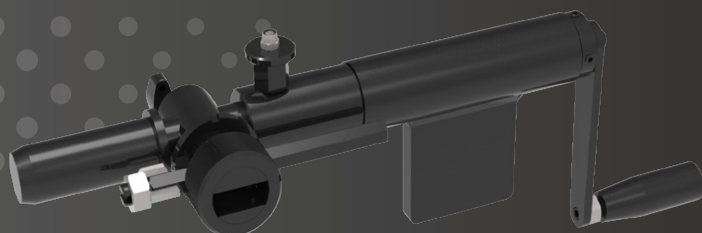

TECHNICAL SPECIFICATIONS

CAPACITY

2wb: 2" max.

4ws: 2" max.

DIMENSIONS

413 x 52 x 224 mm

(16 x 2 x 9")

NET WEIGHT

3 kg (7 lb)

TECHNICAL FEATURES

Tool selection:

- External Skiving Kit (ESE)
including 10 mandrels (6-8-10-13-16-19-25-32-38-50)

- Internal Skiving Kit (IS)
including 7 mandrels (13-16-19-25-32-38-50)

Internal skiving tools can also be ordered per diameter

OPTIONAL

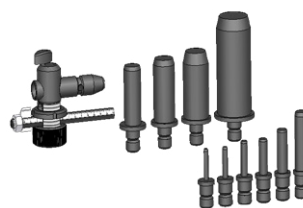

Tool Kit ESE



Tool Kit IS

M 50 SKY

SMALL SERVICE WORKSHOP
BENCHTOP SKIVING

SKIVING
MACHINES
10

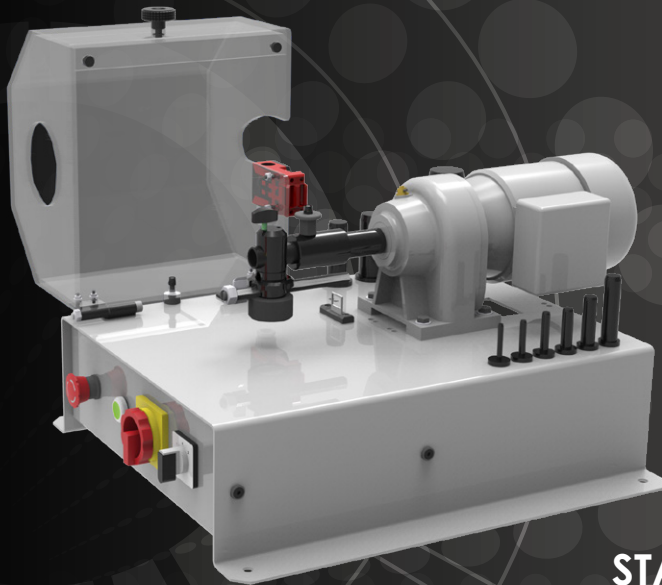

KEY FEATURES

- Plug'n skive system
- Compact & stable
- Safety switch on the cover
- Good visibility
- Tool storage included
- Foot pedal drive with emergency stop
- 2-way rotation

STANDARD



CME Electrical Foot Switch

OPTIONAL

TECHNICAL SPECIFICATIONS

CAPACITY

2wb: 2" max.
4ws: 2" max.

ROTATION SPEED

100 rpm

MOTOR

0.25 kW

VOLTAGES

220/240 V, 1Ph, 50 Hz
380/415 V, 3Ph, 50 Hz
220/240 V, 1Ph, 60 Hz
380/415 V, 3Ph, 60 Hz

DIMENSIONS

500 x 660 x 360 mm
(19 x 26 x 14")

PACKAGING

800 x 600 x 700 mm
(31 x 24 x 28")

NET WEIGHT

45 kg (99 lb)

GROSS WEIGHT

55 kg (121 lb)

TECHNICAL FEATURES

Tools available (to be ordered separately)
ESE, IS, ESP1, ESP2



Tool Kit IS

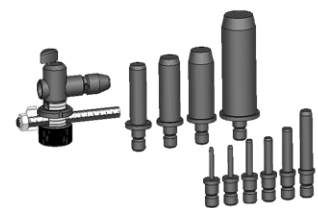

Tool Kit ESE

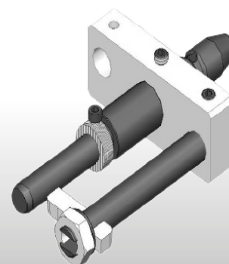

Tool Kit ESP 1

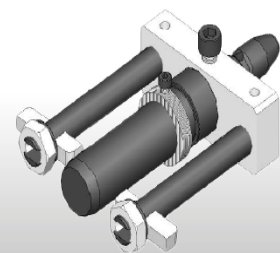

Tool Kit ESP 2

M 300 SKY

STARTER & PROFESSIONAL WORKSHOP
STAND TYPE SKIVING MACHINE

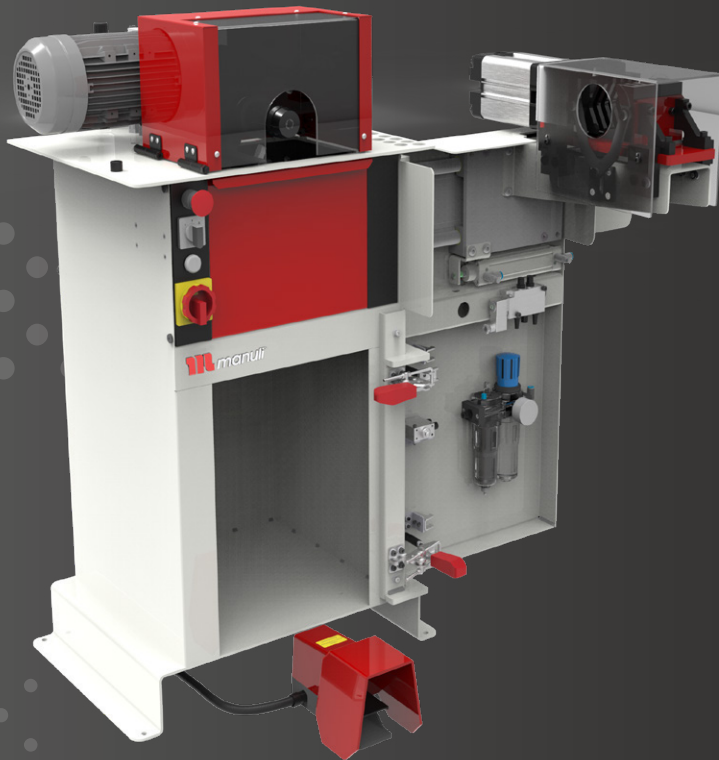

Model shown: OEM version with Pneumatic Clamping system option

KEY FEATURES

- Plug'n skive system
- Large dust collector
- Robust & easily adjustable knife for quick and easy changeover
- Suitable for high volume production
- 2-way rotation

TECHNICAL SPECIFICATIONS

CAPACITY

- 2wb: 2" max.
- 4ws: 2" max.
- 6ws: 3" max. with original tools

ROTATION SPEED

300 rpm

MOTOR

0.9 kW

VOLTAGES

- 220/240 V, 3Ph, 50 Hz
- 380/415 V, 3Ph, 50 Hz
- 208/240 V, 3Ph, 60 Hz
- 380/415 V, 3Ph, 60 Hz

DIMENSIONS

675 x 550 x 1130 mm
(27 x 22 x 44")

PACKAGING

800 x 600 x 1200 mm
(32 x 24 x 47")

NET WEIGHT

100 kg (220 lb)

GROSS WEIGHT

160 kg (353 lb)

TECHNICAL FEATURES

Options available: speed regulator, hose clamping system (limited to distribution workshop using sizes under 2")

Tools available (to be ordered separately): ESA, IS, ESP1, ESP2

OPTIONAL



Tool Kit IS



Tool Kit ESA

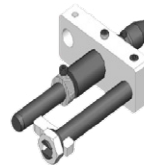

Tool Kit ESP 1

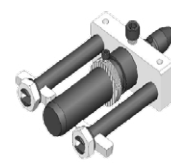

Tool Kit ESP 2

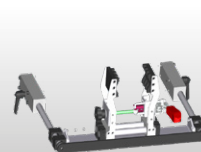

Manual Hose Clamping System

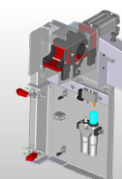

Pneumatic Hose Clamping System



Speed Regulator

ACCESSORIES AND TOOLS

EXTERNAL SKIVING TOOLS

Depending on the machine and on customer needs, Manuli Hydraulics offers 3 types of external skiving tools:

ESE (EXTERNAL SKIVING ECONOMIC)

For MH SKY, M 50 SKY and M 30 CUT & SKIVE

The ESE kit includes 10 mandrels: $\frac{1}{4}$ " , $\frac{5}{16}$ " , $\frac{3}{8}$ " , $\frac{1}{2}$ " , $\frac{5}{8}$ " , $\frac{3}{4}$ " , 1" , $1\frac{1}{4}$ " , $1\frac{1}{2}$ " , 2"

ESA (EXTERNAL SKIVING ADJUSTABLE)

For M 205 SKY

The ESA kit includes 11 mandrels: $\frac{3}{16}$ " , $\frac{1}{4}$ " , $\frac{5}{16}$ " , $\frac{3}{8}$ " , $\frac{1}{2}$ " , $\frac{5}{8}$ " , $\frac{3}{4}$ " , 1" , $1\frac{1}{4}$ " , $1\frac{1}{2}$ " , 2"

ESA mandrels are also available in $2\frac{1}{2}$ " and 3"

ESP (EXTERNAL SKIVING PRODUCTION)

For S Skive 100 and P Skive 205

ESP tools are individual 'skiving heads' intended to be pre-set to the right depth and length for greater productivity. They are recommended for batch skiving operations and a second knife can be added for abrasion resistant covers.

ESP is available in: $\frac{3}{16}$ " , $\frac{1}{4}$ " , $\frac{5}{16}$ " , $\frac{3}{8}$ " , $\frac{1}{2}$ " , $\frac{5}{8}$ " , $\frac{3}{4}$ " , 1" , $1\frac{1}{4}$ " , $1\frac{1}{2}$ " , 2" , $2\frac{1}{2}$ " and 3"

INTERNAL SKIVING TOOLS

IS (INTERNAL SKIVING)

For all machines

The IS kit includes 7 mandrels: $\frac{1}{2}$ " , $\frac{5}{8}$ " , $\frac{3}{4}$ " , 1" , $1\frac{1}{4}$ " , $1\frac{1}{2}$ " , 2"

They are also available in $\frac{5}{8}$ " , $2\frac{1}{2}$ " and 3"

The ring is heat treated to resist the abrasion of the hose wires.

Optional venturi system with IS tool.

ACCESSORIES AND TOOLS

HOSE CLAMPING SYSTEM

Recommended for skiving hoses over 2" (DN 50)

PLUG N'SKIVE SYSTEM

All Manuli Hydraulics skiving machines are equipped with the Plug'n Skive System which allows the quick and easy insertion of tools.

With the Plug n'Skive System no tools are needed to insert the skiving mandrel, simply push the mandrel into the locking system to unlock it, lift a knob and pull out the tool.

M 1500 INS

EXPERT SERVICE LINE
BENCHTOP COUPLING INSERTER

KEY FEATURES

- Compact
- Sturdy
- Powerful
- Hydro pneumatic power pack

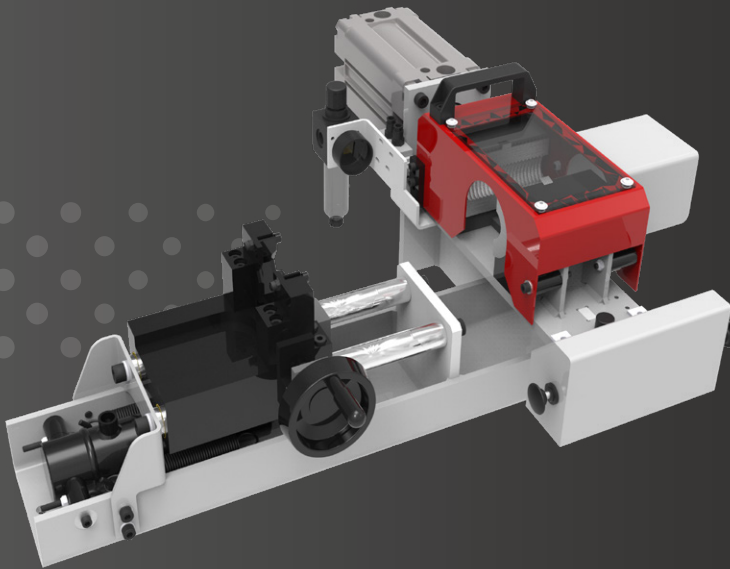

STANDARD

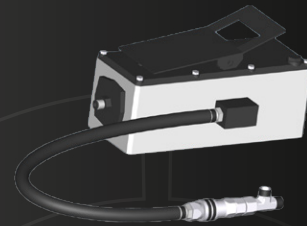

Hydro-pneumatic pump

TECHNICAL SPECIFICATIONS

CAPACITY

- 2wb: 2" max.
- 4ws: 2" max.
- 6ws: 2" max.

DIMENSIONS

750 x 660 x 300 mm
(30 x 26 x 12")

NET WEIGHT

70 kg (154 lb)

POWER SUPPLY

Compressed air (7 bar)

TECHNICAL FEATURES

Optional tool: for small bore 1/4", 3/8", 1/2" shell

M 2000 INS

EXPERT SERVICE LINE
BENCHTOP COUPLING INSERTER

KEY FEATURES

- Compact
- Sturdy
- Powerful
- Manual insert centring device
- Joystick operated clamping & insertion

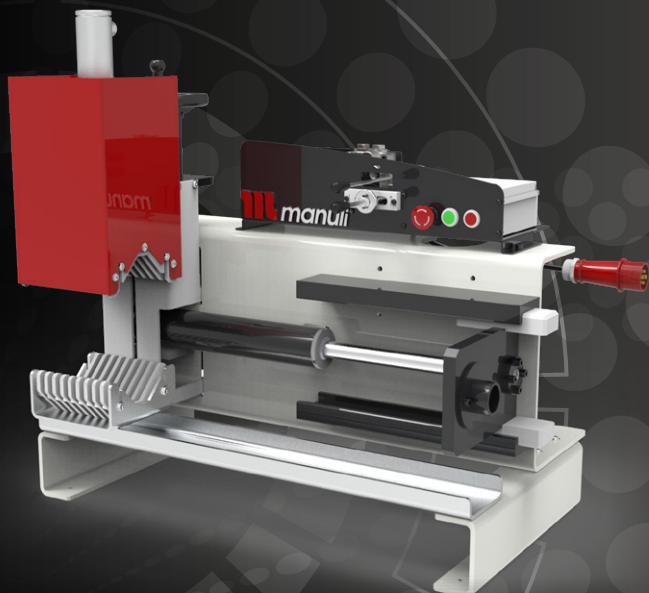

INSERT PUSHING MACHINES 16

TECHNICAL SPECIFICATIONS

CAPACITY	MAXIMUM FLANGE
76 mm - 170 mm OD hose	250 mm
DIMENSIONS	INSERTION FORCE
800 x 500 x 900 mm (31 x 20 x 35")	20,000 N
NET WEIGHT	INSERTION STROKE
150 kg (330 lb)	300 mm
VOLTAGES	INSERTION SPEED*
380/415 V, 3Ph, 50 Hz	28 mm/s
POWER	CLAMPING LENGTH
1.5 kW	200 mm

*Electrical version only

OPTIONS

Manual version available



M 50 MARK

AFTER MARKET SERVICE
BENCHTOP, FERRULE MARKING

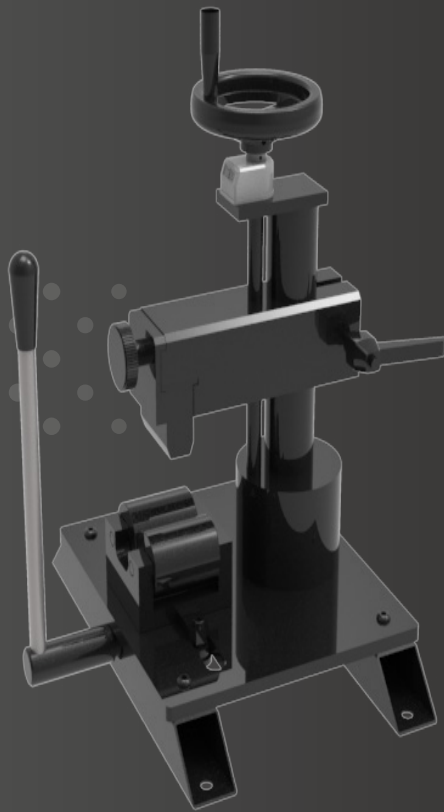

KEY FEATURES

Robust

Easy to use

Compact

Large space for 14 stamps

Stamp holder with numbering wheel;
3 figures on the wheel + 1 groove for
stamps

TECHNICAL SPECIFICATIONS

CAPACITY

2wb: 4" max.

4ws: 4" max.

DIMENSIONS

390 x 360 x 520 mm

(15 x 14 x 20")

PACKAGING

800 x 600 x 830 mm

(31 x 24 x 33")

NET WEIGHT

34 kg (75 lb)

GROSS WEIGHT

50 kg (110 lb)

STANDARD STAMP HOLDER

2 x 14 stamps

SIZE OF THE STAMPS

6 x 3 mm

(0.236 x 0.118")

HEIGHT OF THE LETTERS

2.5 mm

(0.098")

TECHNICAL FEATURES

Optional stamp holder with numbering wheel: 3 figures on the wheel and one groove for 10 stamps

STAMP BOX

Includes stamp box of 100 stamps & 20 blanks

CK 50



TECHNICAL SPECIFICATIONS

NUMBER OF NOZZLES

10 to suit hose ID

COMPRESSED AIR

7 bar

MINIMUM INTERNAL DIAMETER OF HOSE

6 mm

MAXIMUM INTERNAL DIAMETER

51 mm

TECHNICAL FEATURES

Includes 575 pellets & projectile catcher

HRD 07

HOSES CAN BE STORED ON THE HOSE DISPENSER



TECHNICAL SPECIFICATIONS

MAXIMUM NUMBER OF COILS

7

MAXIMUM WEIGHT/COIL

80 kg

MINIMUM INTERNAL DIAMETER

300 mm

MINIMUM EXTERNAL DIAMETER

850 mm

MAXIMUM HEIGHT

200 mm

DIMENSIONS

1180 x 1180 x 2115 mm (100 kg)

PACKAGING

1200 x 1200 x 720 mm (135 kg)

DV 32 - OEM DECOILER

DV 32



OEM



The hose decoiler is highly adaptable, suitable for a hose reel or a coil up to 100 kgs. It is stable and equipped with a hose guide system and a manual break, offering increased safety and efficiency. The OEM decoiler is also available with electric drive.

INDUSTRIAL DECOILER

Robust, motorised decoiler for large bore industrial hose. Comes with 6 manually adjustable centring pins, remote stop-start controller and a high torque, 3kW motor with speed control.



VOLTAGES

400 V, 3Ph, 50 Hz

DIMENSIONS

2600 x 2600 x 1600 mm
(102 x 102 x 63")

NET WEIGHT

714 kg (1570 lb)

MOTOR

3 kW with speed control

POWER TORQUE

1200 N

TABLE DIAMETER

2200 mm

MHP 80

FIELD SERVICE & MOBILE WORKSHOP
HAND PUMP, PORTABLE

KEY FEATURES

- Compact
- Lightweight
- Easy to use
- Balanced design
- Dual stage pump

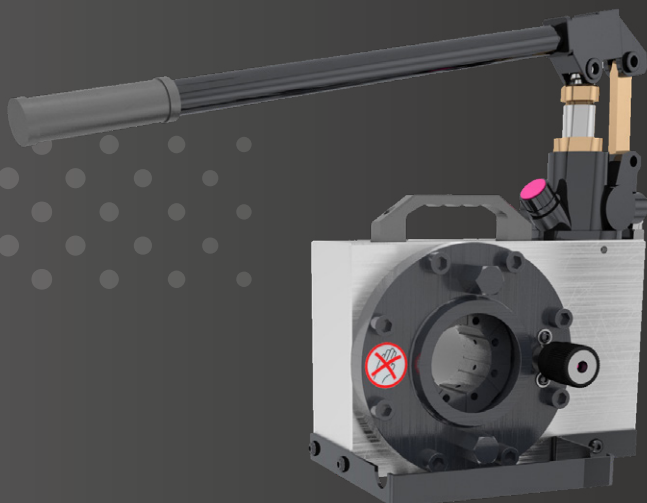

TECHNICAL SPECIFICATIONS

CAPACITY*

2wb: 1" max.

4ws: ½" max.

CRIMP RANGE

6 - 43 mm (0.157 - 1.693")

CRIMP FORCE

80 t

OPENING WITH DIES

+20 mm (+0.787")

COMPLETE OPENING

59 mm (2.323")

MASTER DIE LENGTH

56 mm (2.205")

STANDARD DIES

15, 18, 21, 24, 27, 30, 39**

DIMENSIONS

330 x 250 x 400 mm

(13 x 10 x 16")

PACKAGING

800 x 600 x 830 mm

(31 x 24 x 33")

NET WEIGHT

28 kg (62 lb)

GROSS WEIGHT

41 kg (90 lb)

TECHNICAL FEATURES

Hand pump: 5000 psi
(double speed)

OPTIONAL



Maintenance Kits

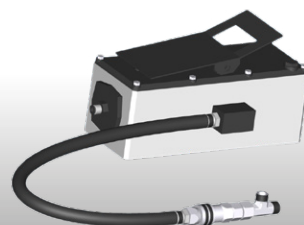

Hydro-pneumatic
Pump

*Indicative capacities depending on hose and fitting type

** Master die is used as die set No. 39

MHP 110

FIELD SERVICE & MOBILE WORKSHOP
HAND PUMP, PORTABLE

KEY FEATURES

- Flexible
- Portable
- Robust (protected narrow head)
- Multi-positioning (with removable plate)

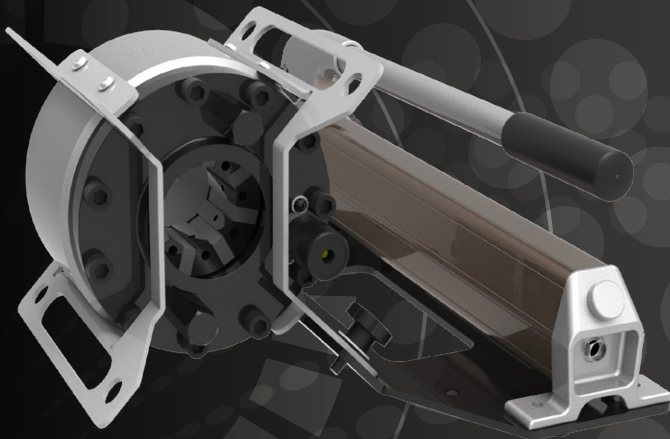

TECHNICAL SPECIFICATIONS

CAPACITY*	STANDARD DIES
2wb: 1" max.	15, 18, 21, 24, 27, 30
4ws: 1" max.	DIMENSIONS
CRIMP RANGE	540 x 400 x 225 mm
6 - 43 mm (0.236 - 1.693")	(21 x 16 x 9")
CRIMP FORCE	PACKAGING
110 t	800 x 600 x 830 mm
OPENING WITH DIES	(31 x 24 x 33")
+20 mm (+0.787")	NET WEIGHT
COMPLETE OPENING	28 kg (62 lb)
59 mm (2.323")	WEIGHT (HEAD ONLY)
MASTER DIE LENGTH	21 kg (46 lbs)
60 mm (2.362")	

*Indicative capacities depending on hose and fitting type

OPTIONAL



Maintenance Kits

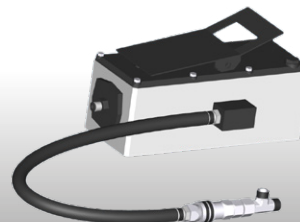

Hydro-pneumatic Pump

MHP 137

FIELD SERVICE & MOBILE WORKSHOP
HAND PUMP, PORTABLE

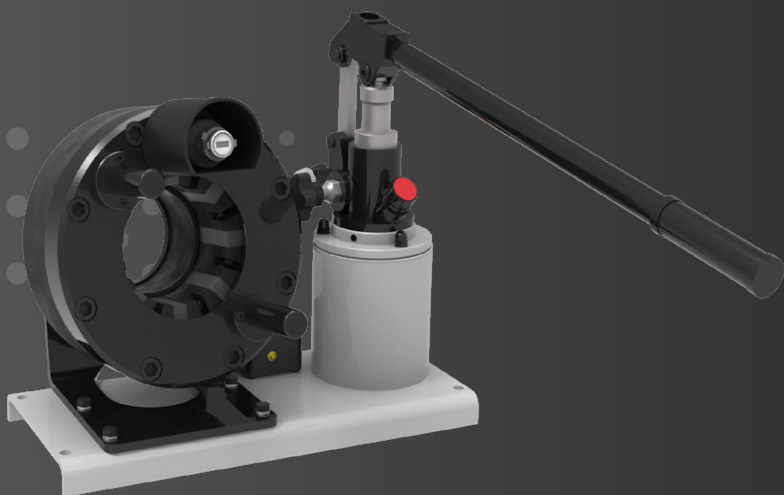

KEY FEATURES

- High capacity
- Narrow head
- Audio-visual signal
- 350 bar technology more robust & reliable than 700 bar
- Large opening

TECHNICAL SPECIFICATIONS

CAPACITY*

2wb / 4ws: 1¼" max.
Industrial: 1½" max.

CRIMP RANGE

4 - 70 mm (0.157 - 2.756")

CRIMP FORCE

137 t

OPENING WITH DIES

+28 mm (+1.102")

COMPLETE OPENING

100 mm (3.937")

MASTER DIE LENGTH

75 mm (2.962")

STANDARD DIES

15, 18, 21, 24, 27, 30, 33, 36,
39, 42, 45, 48, 51
and Refrifast dies 14, 18, 21

DIMENSIONS

480 x 250 x 340 mm
(19 x 10 x 13")

PACKAGING

800 x 600 x 830 mm
(31 x 24 x 33")

NET WEIGHT

55 kg (121 lb)

GROSS WEIGHT

75 kg (165 lb)

*Indicative capacities depending on hose and fitting type

OPTIONAL



Maintenance Kit



Quick Change Gun



Aluminium Quick Change Gun



Die Storage Panel



Hydro-pneumatic Pump



Marking Dies



Die Sets for Brake & Air Conditioning Hoses

MRB 137 EVO R

**MAINTENANCE WORKSHOP
VERTICAL BENCHTOP**

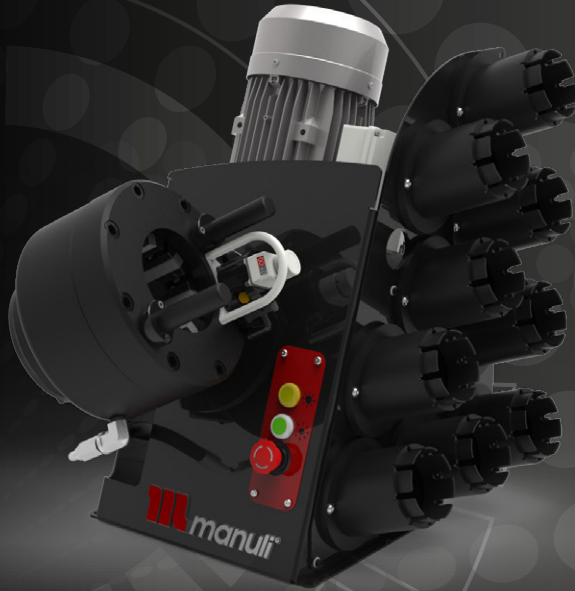

KEY FEATURES

- Ergonomically positioned adjustable head
- Axis of the head situated perpendicular to the operator
- Compact
- Optional quick change tool for dies
- Range of standard dies available

TECHNICAL SPECIFICATIONS

CAPACITY*

2wb / 4ws: 1¼" max.
Industrial: 1½" max.

CRIMP RANGE

4 to 70 mm (0.157 - 2.756")

CRIMP FORCE

137 t

OPENING WITH DIES

+28 mm (+1.102")

COMPLETE OPENING

100 mm (3.937")

MASTER DIE LENGTH

75 mm (2.953")

STANDARD DIES

15, 18, 21, 24, 27, 30, 33, 36,
39, 42, 45, 48, 51

NOISE LEVEL

70 dB A

*Indicative capacities depending on hose and fitting type

MOTOR

1.5 kW (110V)
2.2 kW (230V)

VOLTAGES

110 V, 1Ph, 60 Hz
220/240 V, 1 Ph, 50 Hz
380/415V, 3 Ph + N, 50 Hz
+12/24

Other voltages available on request

DIMENSIONS

360 x 530 x 620 mm
(14 x 21 x 25")

NET WEIGHT

85 kg (187 lb)

GROSS WEIGHT

89 kg (196 lb)

OPTIONAL



Maintenance Kit



Die Storage Panel



Aluminium Quick Change Gun



Quick Change Gun

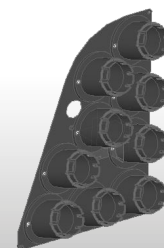

Die Storage Panel EVO R

MB 137 EVO

ASSEMBLING FOR FIELD REPAIR BENCHTOP CRIMP MACHINE

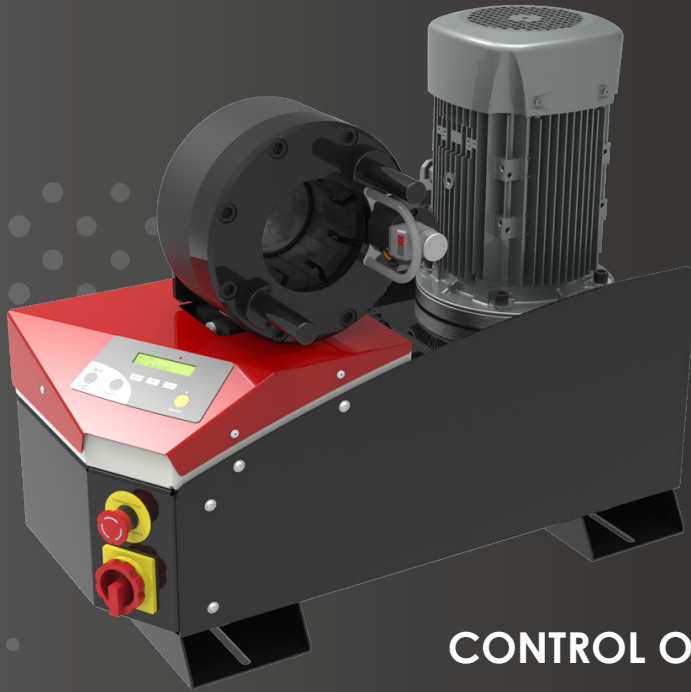

KEY FEATURES

- Crimp force of up to 137 tonnes for hoses up to 1¼"
 - Easy to use and robust
 - Extensive range of dies to suit crimping of hydraulic hoses
 - Easy to set up and maintain
 - Fast and reliable
 - Digital micrometer
 - Optional calliper on SCE & SCS panel
- Model shown equipped with SC control panel

CONTROL OPTIONS AVAILABLE ON REQUEST



TECHNICAL SPECIFICATIONS

CAPACITY*

2wb / 4ws: 1¼" max.
Industrial: 1½" max.

CRIMP RANGE

4 - 70 mm (0.157 - 2.756")

CRIMP FORCE

137 t

OPENING WITH DIES

+28 mm (+1.102")

COMPLETE OPENING

100 mm (3.937")

MASTER DIE LENGTH

75 mm (2.953")

STANDARD DIES

15, 18, 21, 24, 27, 30, 33, 36,
39, 42, 45, 48, 51

NOISE LEVEL

70 dB A

MOTOR

4.0 kW

VOLTAGES

220/240 V, 3Ph, 50 Hz

380/415 V, 3Ph, 50 Hz

208/240 V, 3Ph, 60 Hz

380/415 V, 3Ph, 60 Hz

Other voltages available on request - 1Ph 220/240 V option uses 3 kW motor

DIMENSIONS

765 x 400 x 650 mm

(30 x 16 x 26")

NET WEIGHT

160 kg (353 lb)

*Indicative capacities depending on hose and fitting type

OPTIONAL



MB 240 EVO

PROFESSIONAL WORKSHOP
BENCHTOP

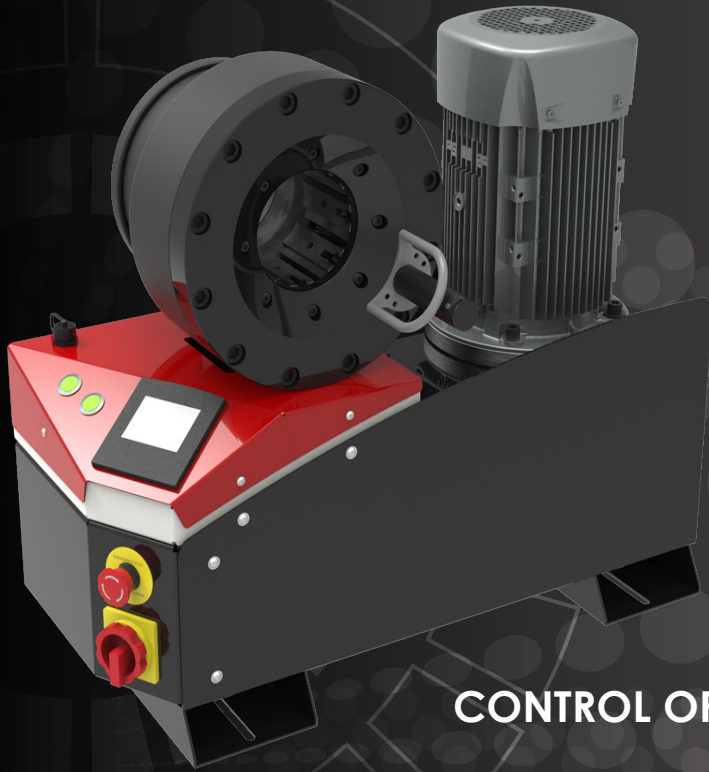

KEY FEATURES

- Crimp force of up to 240 tonnes for hoses up to 2"
 - Easy to use and robust
 - Radial die movement
 - High crimping force
 - Extensive range of dies to suit crimping of hydraulic hoses
 - Easy set up and maintenance
 - Fast and reliable
 - Optional calliper on SCE & SCS panel
- Model shown equipped with SCE control panel

CONTROL OPTIONS AVAILABLE ON REQUEST



TECHNICAL SPECIFICATIONS

CAPACITY*

- 2wb: 2" max.
- 4ws: 2" max.
- 6ws: 1 1/4" max.

CRIMP RANGE

4 - 76 mm (0.157 - 2.992")

CRIMP FORCE

240 t

OPENING WITH DIES

+38 mm (+1.496")

COMPLETE OPENING

118 mm (4.645")

MASTER DIE LENGTH

100 mm (3.937")

STANDARD DIES

- 15, 18, 21, 24, 27, 30, 33, 36,
- 39, 42, 45, 48, 51, 57, 62,
- 66, 70

*Indicative capacities depending on hose and fitting type

NOISE LEVEL

<70 dB A

MOTOR

4.0 kW

VOLTAGES

220/240 V, 3Ph, 50 Hz

380/415 V, 3Ph, 50 Hz

208/240 V, 3Ph, 60 Hz

380/415 V, 3Ph, 60 Hz

Other voltages available on request - 1Ph 220/240 V option uses 3 kW motor

DIMENSIONS

765 x 400 x 650 mm

(30 x 16 x 26")

NET WEIGHT

165 kg (364 lb)

OPTIONAL



Maintenance Kit



Marking Dies



Die Storage Panel



Die Storage Table



Electrical Footswitch



Quick Change Gun



Aluminium Quick Change Gun



Mechanical Backstop



Die Sets for Brake & Air Conditioning Hoses



Bluetooth



Die Storage Panel EVO

MB 350 EVO

FULL SERVICE WORKSHOP
BENCHTOP; VERY HIGH CRIMP FORCE



KEY FEATURES

- Crimp force of up to 350 tonnes for hoses up to 3"
 - Easy to use and robust
 - Automatic maintenance alerts
 - Groove for 90° long drop fittings
 - Optional calliper on SCE & SCS panel
- Model shown equipped with SCS control panel

CONTROL OPTIONS AVAILABLE ON REQUEST



TECHNICAL SPECIFICATIONS

CAPACITY*

2wb: 3" max.
Textile / Suction Hose: 4" max.
4ws: 2" max.
6ws: 2" max.

CRIMP RANGE

4 - 130 mm (0.157 - 5.118")

CRIMP FORCE

350 t

OPENING WITH DIES

+54 mm (+2.125")

COMPLETE OPENING

180 mm (7.086")

MASTER DIE LENGTH

115 mm (4.523")

STANDARD DIES

15, 18, 21, 24, 27, 30, 33, 36,
39, 42, 45, 48, 51, 57, 62,
66, 70, 73, 76

*Indicative capacities depending on hose and fitting type

NOISE LEVEL

<70 dB A

MOTOR

5.5 kW

VOLTAGES

220/240 V, 3Ph, 50 Hz

380/415 V, 3Ph, 50 Hz

208/240 V, 3Ph, 60 Hz

380/415 V, 3Ph, 60 Hz

Other voltages available on request - 1Ph 220/240V option uses 3 kW motor

DIMENSIONS

765 x 400 x 750 mm
(30 x 16 x 30")

NET WEIGHT

262 kg (578 lb)

OPTIONAL



Maintenance Kit



Marking Dies



Die Storage Panel



Die Storage Table



Electrical Footswitch



Quick Change Gun



Aluminium Quick Change Gun



Mechanical Backstop



Die Sets for Brake & Air Conditioning Hoses



Bluetooth



Die Storage Panel EVO

GOLDENCRIMP 420 EVO

ASSEMBLING FOR FIELD REPAIR
BENCHTOP CRIMP MACHINE



KEY FEATURES

- High crimping force of 420 tonnes
- Robust design for transport and operation in harsh environments
- Protected cylinders for trouble-free operation in high dust environments
- Large opening suitable for large bore hoses
- Easy maintenance due to foam pad dust collector
- Optional calliper on SCE & SCS panel

Model shown equipped with SCS control panel

CONTROL OPTIONS AVAILABLE ON REQUEST

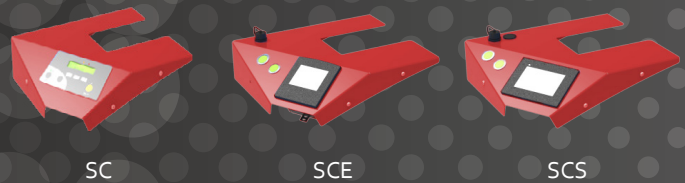

TECHNICAL SPECIFICATIONS

CAPACITY*	NOISE LEVEL
6ws: 3" max. Industrial: 4" max.	<70 dB A
CRIMP RANGE	MOTOR
4 - 130 mm (0.157 - 5.118")	5.5 kW
CRIMP FORCE	VOLTAGES
420 t	220/240 V, 3Ph, 50 Hz 380/415 V, 3Ph, 50 Hz
OPENING WITH DIES	208/240 V, 3Ph, 60 Hz 380/415 V, 3Ph, 60 Hz
+48 mm (+1.9 inch)	DIMENSIONS
COMPLETE OPENING	765 x 500 x 800 mm (30 x 20 x 32")
178 mm (7.0 inch)	PACKAGING
MASTER DIE LENGTH	745 x 1150 x 945 mm (29 x 45 x 37")
120 mm (4.724 inch)	NET WEIGHT
STANDARD DIES	395 kg (871 lb)
15, 18, 21, 24, 27, 30, 33, 36, 39, 42, 45, 48, 51, 57, 62, 66, 70, 73, 76	

*Indicative capacities depending on hose and fitting type

OPTIONAL

- Maintenance Kit (GREEN, YELLOW, RED)
- Marking Dies
- Die Storage Panel
- Die Storage Table
- Electrical Footswitch
- Quick Change Gun
- Aluminium Quick Change Gun
- Die Sets for Brake & Air Conditioning Hoses
- Bluetooth
- Die Storage Panel EVO

GOLDENCRIMP 450

ASSEMBLING FOR FIELD REPAIR BENCHTOP CRIMP MACHINE

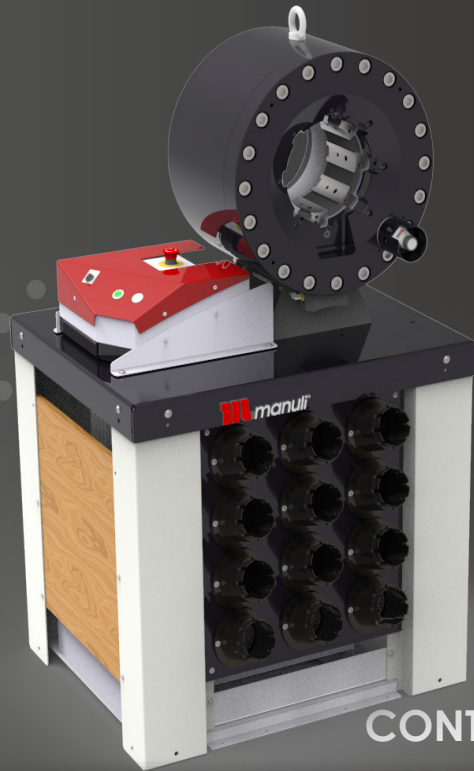

KEY FEATURES

- High crimp force (450 tonnes)
- Large opening
- Wide family of dies for industrial hoses
- Long master dies
- Robust - designed for harsh environments
- Low noise level
- Easy die set-up with ergonomic gun
- Metallic guard for the set stop

CONTROL OPTIONS AVAILABLE ON REQUEST

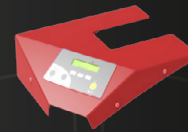

SC

TECHNICAL SPECIFICATIONS

CAPACITY*

6ws: 3" max.
Industrial: 4" max.

CRIMP RANGE

4 - 130 mm (0.157 - 5.118")

CRIMP FORCE

450 t

OPENING WITH DIES

+70 mm (+2.755")

COMPLETE OPENING

197 mm (7.755")

MASTER DIE LENGTH

140 mm (5.512")

STANDARD DIES

15, 18, 21, 24, 27, 30, 33, 36,
39, 42, 45, 48, 51, 57, 62,
66, 70, 73, 76

NOISE LEVEL

<65 dB A

MOTOR

5.5 kW

VOLTAGES

220/240 V, 3Ph, 50 Hz
380/415 V, 3Ph, 50 Hz
208/240 V, 3Ph, 60 Hz
380/415 V, 3Ph, 60 Hz

DIMENSIONS

830 x 775 x 1450 mm
(33 x 31 x 57")

PACKAGING

1120 x 1020 x 1770 mm
(44 x 40 x 70")

NET WEIGHT

720 kg (1587 lb)

*Indicative capacities depending on hose and fitting type

OPTIONAL



Die Storage Panel



Marking Dies



Quick Change Gun



Die Sets for Brake & Air Conditioning Hoses



Aluminium Quick Change Gun

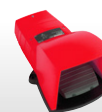

Electrical Footswitch

MRV 137 EVO R

FIELD SERVICE & MOBILE WORKSHOP
MOBILE VAN

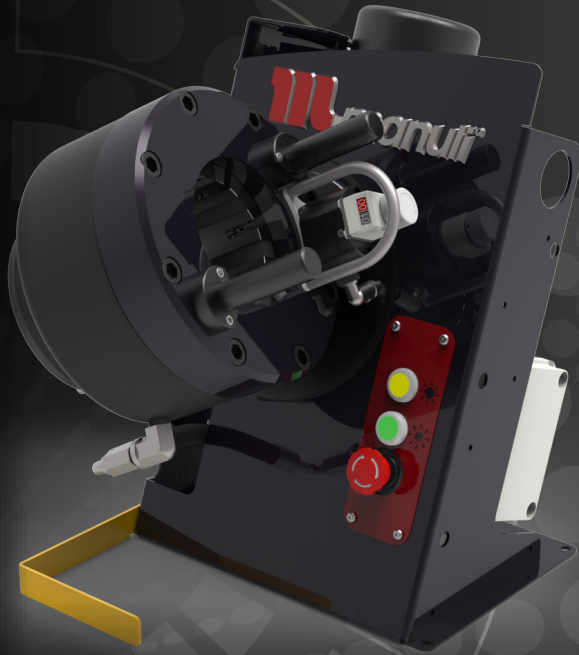

KEY FEATURES

- Ergonomically positioned adjustable head
- Axis of the head situated perpendicular to the operator
- Compact
- Optional quick change tool for dies
- Range of standard dies available

TECHNICAL SPECIFICATIONS

CAPACITY*

2wb / 4ws: 1¼" max.
Industrial: 1½" max.

CRIMP RANGE

6 to 56 mm (0.517 - 2.205")

CRIMP FORCE

137 t

OPENING WITH DIES

+28 mm (+1.102")

COMPLETE OPENING

100 mm (3.937")

MASTER DIE LENGTH

75 mm (2.953")

STANDARD DIES

15, 18, 21, 24, 27, 30, 33, 36,
39, 42, 45, 48, 51

NOISE LEVEL

70 dB A

MOTOR

1.5 kW (12 V)

VOLTAGES

12 V

DIMENSIONS

392 x 398 x 486 mm
(15 x 16 x 19")

NET WEIGHT

73 kg (161 lb)

GROSS WEIGHT

90 kg (199 lb)

*Indicative capacities depending on hose and fitting type

OPTIONAL



Maintenance Kit



Die Storage Panel



Die Storage Table



Quick Change Gun

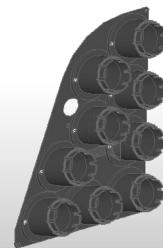

Die Storage Panel EVO R



Aluminium Quick Change Gun

MV 137 L

FIELD SERVICE & MOBILE WORKSHOP
MOBILE VAN



KEY FEATURES

- Robust and compact design
- Lightweight
- High crimping speed
- Suitable also for 90° elbow fittings
- Cylinder protection

TECHNICAL SPECIFICATIONS

CAPACITY*	MOTOR
2wb / 4ws: 1¼" max.	2.0 kW
Industrial: 1½" max.	VOLTAGES
CRIMP RANGE	12 V
4 - 70 mm (0.157 - 2.756")	24 V
CRIMP FORCE	DIMENSIONS
137 t	250 x 320 x 300 mm
OPENING WITH DIES	(10 x 13 x 12")
+28 mm (+1.102")	PACKAGING
COMPLETE OPENING	800 x 600 x 830 mm
100 mm (3.937")	(31 x 24 x 33")
MASTER DIE LENGTH	NET WEIGHT
75 mm (2.952")	86 kg (190 lb)
STANDARD DIES	GROSS WEIGHT
15, 18, 21, 24, 27, 30, 33, 36, 39, 42, 45, 48, 51	102 kg (225 lb)
NOISE LEVEL	TECHNICAL FEATURES
72 dB A	Dimensions of power pack: 440 x 320 x 320 mm (17 x 13 x 13")

*Indicative capacities depending on hose and fitting type

OPTIONAL



Maintenance Kit



Quick Change Gun



Aluminium Quick Change Gun



Die Storage Panel



Marking Dies



Die Sets for Brake & Air Conditioning Hoses



Front Die Storage



Battery & Charger

MV 240

FIELD SERVICE & MOBILE WORKSHOP
MOBILE VAN



KEY FEATURES

- Robust design
- Ergonomic micrometer
- High crimping speed
- Radial movement of the dies
- Cylinder protection
- Remote head mounting option possible

TECHNICAL SPECIFICATIONS

CAPACITY*	MOTOR
2wb: 2" max.	2.0 kW
4ws: 2" max.	VOLTAGES
6ws: 1" max.	12 V
CRIMP RANGE	24 V
4 - 76 mm (0.157 - 2.992")	220/240 V, 3Ph, 50 Hz
CRIMP FORCE	380/415 V, 3Ph, 50 Hz
240 t	208/240 V, 3Ph, 60 Hz
OPENING WITH DIES	380/415 V, 3Ph, 60 Hz
+38 mm (+1.496")	DIMENSIONS
COMPLETE OPENING	650 x 550 x 670 mm
118 mm (4.646")	(26 x 22 x 26")
MASTER DIE LENGTH	PACKAGING
100 mm (3.937")	800 x 600 x 830 mm
STANDARD DIES	(31 x 24 x 33")
15, 18, 21, 24, 27, 30, 33, 36, 39, 42, 45, 48, 51, 57, 62, 66, 70	NET WEIGHT
NOISE LEVEL	118 kg (260 lb)
72 dB A	GROSS WEIGHT
	180 kg (397 lb)

*Indicative capacities depending on hose and fitting type

OPTIONAL



Maintenance Kit



Quick Change Gun



Aluminium Quick Change Gun



Die Storage Panel



Marking Dies



Die Sets for Brake & Air Conditioning Hoses



Front Die Storage



Battery & Charger

MV 240 L

FIELD SERVICE & MOBILE WORKSHOP
MOBILE VAN



KEY FEATURES

- Robust design
- Ergonomic micrometer
- High crimping speed
- Radial movement of the dies
- Cylinder protection

TECHNICAL SPECIFICATIONS

CAPACITY*

2wb: 2" max.

4ws: 2" max.

6ws: 1" max.

CRIMP RANGE

4 - 76 mm (0.157 - 2.992")

CRIMP FORCE

240 t

OPENING WITH DIES

+38 mm (+1.496")

COMPLETE OPENING

118 mm (4.646")

MASTER DIE LENGTH

100 mm (3.937")

STANDARD DIES

15, 18, 21, 24, 27, 30, 33, 36, 39, 42, 45, 48, 51, 57, 62, 66, 70

NOISE LEVEL

72 dB A

TECHNICAL FEATURES

Dimensions of power pack:

440 x 320 x 320 mm (17 x 13 x 13")

*Indicative capacities depending on hose and fitting type

MOTOR

2.0 kW

VOLTAGES

12 V

24 V

220/240 V, 3Ph, 50 Hz

380/415 V, 3Ph, 50 Hz

208/240 V, 3Ph, 60 Hz

380/415 V, 3Ph, 60 Hz

DIMENSIONS

320 x 360 x 350 mm

(13 x 13.5 x 14")

PACKAGING

800 x 600 x 830 mm

(31 x 24 x 33")

NET WEIGHT

130 kg (287 lb)

GROSS WEIGHT

180 kg (397 lb)

OPTIONAL



Maintenance Kit



Quick Change Gun



Aluminium Quick Change Gun



Die Storage Panel



Marking Dies



Die Sets for Brake & Air Conditioning Hoses

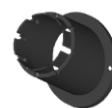

Front Die Storage



Battery & Charger



Ergonomic Micrometer

MV 350

FIELD SERVICE & MOBILE / CONTAINER WORKSHOP
MOBILE VAN



KEY FEATURES

- Robust design
- Large opening
- High crimping force
- Ergonomic micrometer
- High crimping speed
- Radial movement of the dies
- Cylinder protection
- Remote head mounting option possible

TECHNICAL SPECIFICATIONS

CAPACITY*	MOTOR
2wb: 3" max.	2.0 kW
4ws: 2" max.	VOLTAGES
6ws: 2" max.	12 V
Textile / Suction Hose: 4"	24 V
CRIMP RANGE	220/240 V, 3Ph, 50 Hz
4 - 130 mm (0.157 - 5.118")	380/415 V, 3Ph, 50 Hz
CRIMP FORCE	208/240 V, 3Ph, 60 Hz
350 t	380/415 V, 3Ph, 60 Hz
OPENING WITH DIES	DIMENSIONS
+54 mm (+2.125")	650 x 550 x 750 mm
COMPLETE OPENING	(26 x 22 x 30")
180 mm (7.086")	PACKAGING
MASTER DIE LENGTH	800 x 600 x 830 mm
115 mm (4.528")	(31 x 24 x 33")
STANDARD DIES	NET WEIGHT
15, 18, 21, 24, 27, 30, 33, 36, 39, 42, 45, 48, 51, 57, 62, 66, 70, 73, 76	210 kg (463 lb)
NOISE LEVEL	GROSS WEIGHT
<65 dB A	260 kg (573 lb)
	SAFETY REMARK
	Possible limitations in case of double elbow fittings

*Indicative capacities depending on hose and fitting type

OPTIONAL



Maintenance Kit



Quick Change Gun



Aluminium Quick Change Gun



Die Storage Panel



Marking Dies



Die Sets for Brake & Air Conditioning Hoses



Front Die Storage



Battery & Charger

HOSE ROOM ON WHEELS

FIELD SERVICE & MOBILE / CONTAINER WORKSHOP

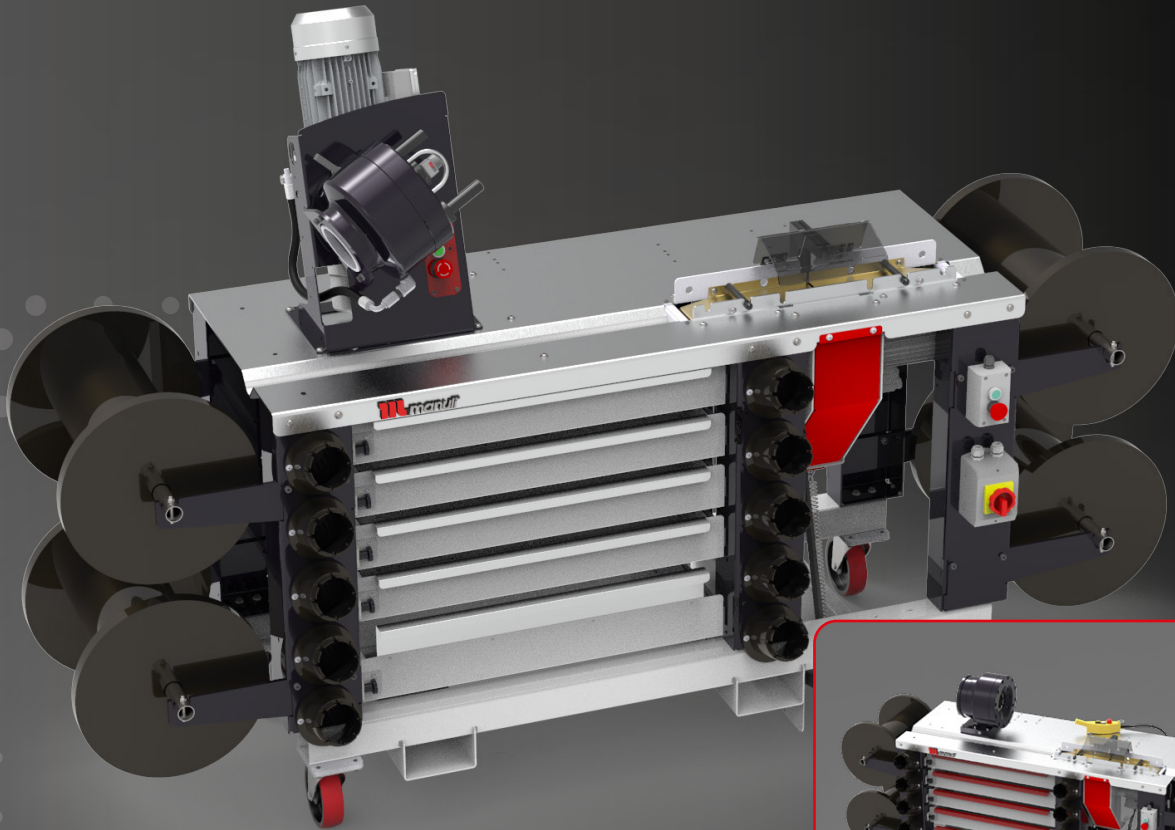

MRB 137 EVO R version

MV 240 L version

TECHNICAL SPECIFICATIONS

	MRB 137 EVO R	MV 240 L
CAPACITY*	4WS - 1 1/4"	
CRIMP FORCE	137 t	240 t
CRIMP RANGE	4 - 70 mm (0.157 - 2.756")	4-76 mm (0.157 - 2.992")
MOTOR	6 kW; 7 kW; 8 kW	5 kW; 7 kW; 8 kW
NET WEIGHT	910 kg	950 kg
DIMENSIONS	2,487 x 810 x 1,661 mm (98 x 32 x 65")	2,487 x 810 x 1,370 mm (98 x 32 x 54")
VOLTAGES	208/240V 3PH 60Hz 220/240V 1PH 50Hz 220/240V 1PH 60Hz 220/240V 3PH 50Hz 380/415V 3PH+N 50Hz	
STANDARD DIES	15, 18, 21, 24, 27, 30, 33, 36, 39, 42, 45, 48, 51	15, 18, 21, 24, 27, 30, 33, 36, 39, 42, 45, 48, 51, 57, 62, 66, 70

*Indicative capacities depending on hose and fitting type

KEY FEATURES

- Robust design
- Available with MRB 137 EVO R and MV 240 L crimping heads
- Integrated cutting machine
- Easy hose spool loading / unloading
- Ball-bearing slide drawers
- Lockable castors
- Remote controller (*MV 240 L version only*)
- Wide range of customisation options available on request (*contact your Manuli sales representative for details*)

MS 200

**ASSEMBLING FOR MASS PRODUCTION
STAND TYPE CRIMP MACHINE, SCS SYSTEM**



KEY FEATURES

- Safe Crimp System (SCS) control
- Large production capacity (small/medium bore)
- Low noise level
- Precise
- Robust
- Easy die set-up with ergonomic gun
- Also available with SC and SCE control panels

STANDARD



Quick Change Gun



Electrical Footswitch

OPTIONAL

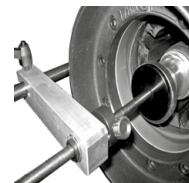

Mechanical Backstop



Aluminium Quick Change Gun



Back View Camera

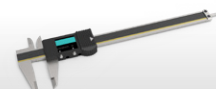

Calliper Option

TECHNICAL SPECIFICATIONS

CAPACITY*	NOISE LEVEL
4ws: 1½" max.	<6g dB A
CRIMP RANGE	MOTOR
4 - 70 mm (0.157 - 2.756")	5.5 kW
CRIMP FORCE	VOLTAGES
200 t	220/240 V, 3Ph, 50 Hz
OPENING WITH DIES	380/415 V, 3Ph, 50 Hz
+51 mm (+2.01")	208/240 V, 3Ph, 60 Hz
COMPLETE OPENING	DIMENSIONS
131 mm (5.16")	890 x 690 x 1380 mm
MASTER DIE LENGTH	(35 x 27 x 54")
95 mm (3.74")	PACKAGING
STANDARD DIES	1120 x 1020 x 1725 mm
15, 18, 21, 24, 27, 30, 33, 36, 39, 42, 45, 48	(44 x 40 x 68")
	NET WEIGHT
	600 kg (1323 lb)

*Indicative capacities depending on hose and fitting type

MS 320

ASSEMBLING FOR MASS PRODUCTION
STAND TYPE CRIMP MACHINE, SCS SYSTEM



KEY FEATURES

- High crimp force
- Large opening
- Safe Crimp System (SCS) control
- Wide family of dies for industrial hoses
- Robust structure
- Fast and ergonomic
- Low noise level
- Easy die-set up with ergonomic gun

STANDARD

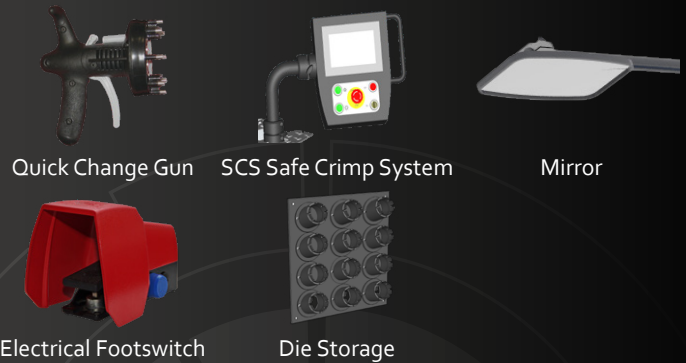

TECHNICAL SPECIFICATIONS

CAPACITY*	NOISE LEVEL
2wb: 3" max.	<65 dB A
4ws: 2" max.	MOTOR
6ws: 2" max.	5.5 kW / 7.5 kW (Fast Version)
Textile & Suction Hose: 4" max.	VOLTAGES
CRIMP RANGE	220/240 V, 3Ph, 50 Hz
4 - 130 mm (0.157 - 5.118")	380/415 V, 3Ph, 50 Hz
CRIMP FORCE	208/240 V, 3Ph, 60 Hz
320 t	380/415 V, 3Ph, 60 Hz
OPENING WITH DIES	DIMENSIONS
+80 mm (+3.149")	1240 x 995 x 1615 mm
COMPLETE OPENING	(49 x 39 x 64")
207 mm (8.149")	PACKAGING
MASTER DIE LENGTH	1400 x 1100 x 1960 mm
100 mm (3.937")	(55 x 43 x 77")
STANDARD DIES	NET WEIGHT
15, 18, 21, 24, 27, 30, 33, 36, 39, 42, 45, 48, 51, 57, 62, 66, 70, 73, 76	2000 kg (4409 lb)
	GROSS WEIGHT
	2300 kg (5071 lb)

*Indicative capacities depending on hose and fitting type

OPTIONAL



Possibility to install eccentric and/or deformed dies

MS 480

**ASSEMBLING FOR MASS PRODUCTION
STAND TYPE CRIMP MACHINE, SCS SYSTEM**



KEY FEATURES

- High crimp force
- Large opening
- Safe Crimp System (SCS) control
- Wide family of dies for industrial hoses
- Long master dies
- Robust
- Low noise level
- Easy die set-up with ergonomic gun

STANDARD



Quick Change Gun

SCS Safe Crimp System

Mirror

Electrical Footswitch

Die Storage

TECHNICAL SPECIFICATIONS

CAPACITY*	NOISE LEVEL
6ws: 3" max. Textile & Suction Hose: 4" max.	<65 dB A
CRIMP RANGE	MOTOR
4 - 160 mm (0.157 - 6.299")	5.5 kW
CRIMP FORCE	VOLTAGES
480 t	220/240 V, 3Ph, 50 Hz 380/415 V, 3Ph, 50 Hz
OPENING WITH DIES	208/240 V, 3Ph, 60 Hz 380/415 V, 3Ph, 60 Hz
+85 mm (+3.346")	DIMENSIONS
COMPLETE OPENING	1300 x 900 x 1700 mm (51 x 35 x 67")
212 mm (8.346")	PACKAGING
MASTER DIE LENGTH	1400 x 1100 x 1960 mm (55 x 43 x 77")
125 mm (4.921")	NET WEIGHT
STANDARD DIES	2200 kg (4850 lb)
15, 18, 21, 24, 27, 30, 33, 36, 39, 42, 45, 48, 51, 57, 62, 66, 70, 73, 76	GROSS WEIGHT
	2430 kg (5357 lb)

*Indicative capacities depending on hose and fitting type

OPTIONAL



Die Storage Panel

Marking Dies

Back View Camera

Aluminium Quick Change Gun

Mechanical Backstop

Side Table & Pushing Panel

Die Sets for Brake & Air Conditioning Hoses

Calliper Option

MS 800

**ASSEMBLING FOR LARGE BORE HOSES
STAND TYPE CRIMP MACHINE, SCS CONTROL**

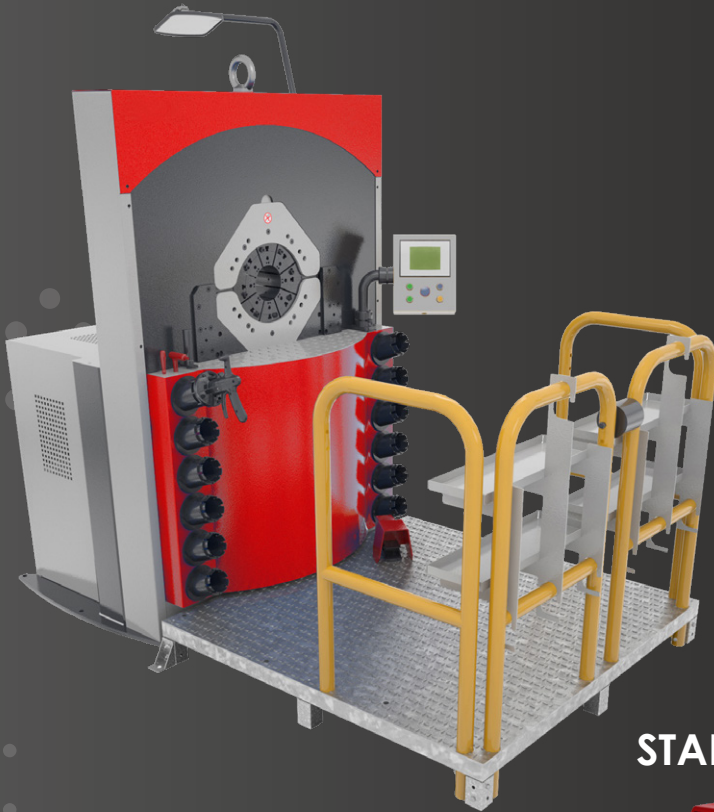

KEY FEATURES

- Designed for heavy duty large bore hydraulic hoses
- High power and speed
- Ergonomically designed for large bore hoses
- Safe Crimp System (SCS) for maximum reliability during the crimping process
- Large opening up to 8"
- Long master dies
- Very high crimping force

STANDARD



Electrical Footswitch



Hose Support



SCS Safe Crimp System

TECHNICAL SPECIFICATIONS

CAPACITY*

- 4ws: 4" max.
- 6ws: 3" max.
- Industrial: 6"

CRIMP RANGE

4 - 230 mm (0.157 - 9.055")

CRIMP FORCE

800 t

OPENING WITH DIES

+100 mm (+3.937")

COMPLETE OPENING

347 mm (13.661")

MASTER DIE LENGTH

180 mm (7.087")

NOISE LEVEL

< 70 dB A

MOTOR

7.5 kW

VOLTAGES

380/415 V, 3Ph, 50 Hz

DIMENSIONS

1400 x 1400 x 2060 mm
(55 x 55 x 81")

NET WEIGHT

4300 kg (9480 lb)

GROSS WEIGHT

5000 kg (11023 lb)

TECHNICAL FEATURES

- Machine platform equipped with rollers to support the hose at working height (1100 mm) in order to handle large bore hoses more easily
- Supplied as standard: Intermediate dies 250/130

*Indicative capacities depending on hose and fitting type

OPTIONAL



Quick Change Gun



Die Storage Panel



Back View Camera

MS 320 OPEN HEAD

**PESO 320
XXL WORKSHOP**

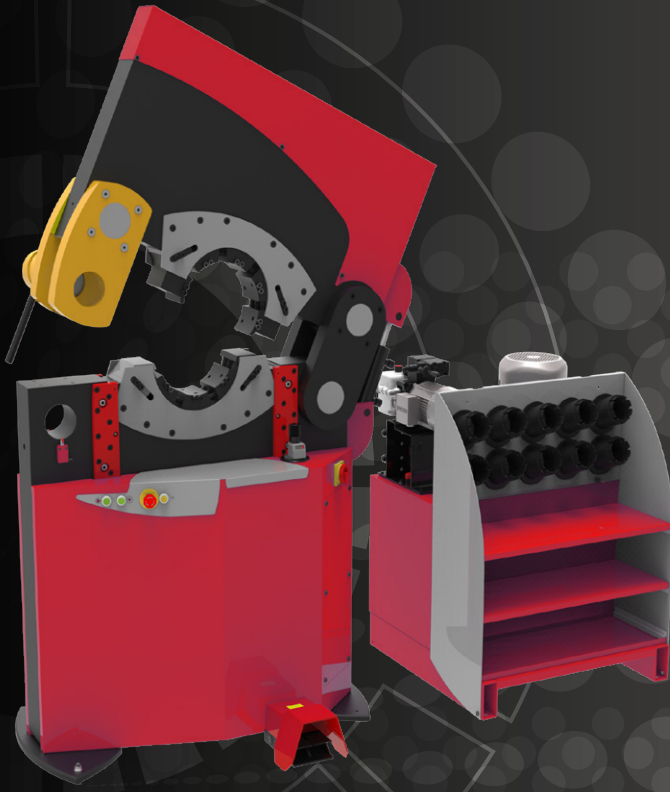

KEY FEATURES

- Unique on market
- Lateral opening
- No limit on end connection diameter
- Easy to use
- Separated power pack
- Integrated safety system

TECHNICAL SPECIFICATIONS

STANDARD

CAPACITY*	VOLTAGES
Industrial: 6"	230 V, 3 Ph
CRIMP RANGE	400 V, 3 Ph
4 - 230 mm (0.157 - 9.055")	MACHINE DIMENSIONS
CRIMP FORCE	1265 x 680 x 1800 mm
320 t	(50 x 27 x 71")
OPENING WITH DIES	POWER PACK DIMENSIONS
+55 mm (+2.165")	890 x 800 x 1050 mm
COMPLETE OPENING	(35 x 31 x 41")
260 mm (10.236")	MACHINE WEIGHT
LATERAL OPENING	1700 kg (3748 lb)
247 mm (9.724")	POWER PACK WEIGHT
MASTER DIE LENGTH	400 kg (882 lb)
125 mm (4.921")	TECHNICAL FEATURES
MOTOR	-Die sizes available upon request
5.5 kW	



Electrical Footswitch



Die Storage

*Indicative capacities depending on hose and fitting type

MS 400

**PE 280
XXL WORKSHOP**

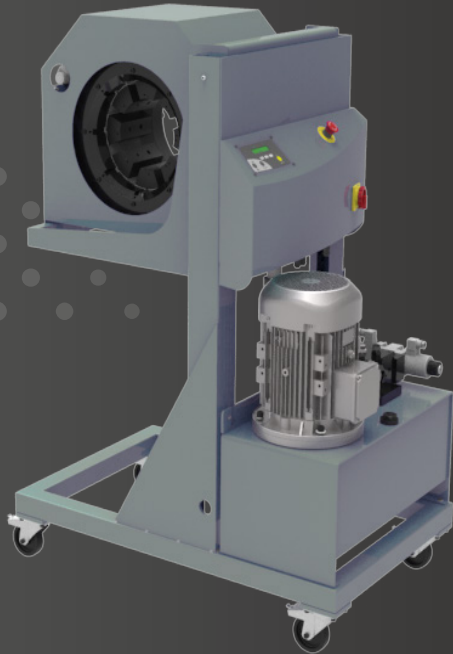

KEY FEATURES

- High crimping force
- Ergonomic operation
- Economic solution
- Large opening
- Robust
- Easy set up
- Versatile
- Adjustable crimping working position

STANDARD



Remote Control



Ergonomic Micrometer

TECHNICAL SPECIFICATIONS

CAPACITY*

Industrial: 6"

CRIMP RANGE

4 - 210 mm (0.157 - 8.268")

CRIMP FORCE

400 t

OPENING WITH DIES

+50 mm (+1.969")

COMPLETE OPENING

285 mm (11.221")

MASTER DIE LENGTH

150 mm (5.906")

MOTOR

5.5 kW

VOLTAGES

230 V, 3 Ph

400 V, 3 Ph

DIMENSIONS

1100 x 900 x 1550 mm

(43 x 35 x 61")

WEIGHT

750 kg (165 lbs)

TECHNICAL FEATURES

-Die sizes available upon request

OPTIONAL



Electrical Footswitch

*Indicative capacities depending on hose and fitting type

MS 450-200

XXL WORKSHOP

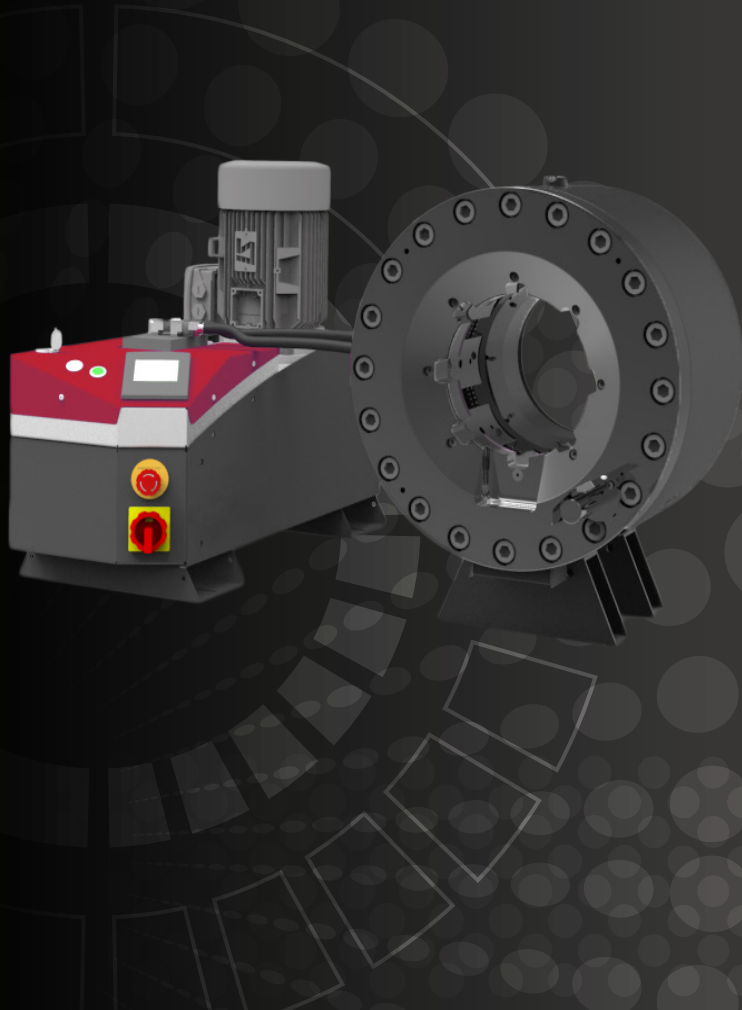

KEY FEATURES

- High crimp force (450 tonnes)
- Large opening
- Wide family of dies for industrial hoses
- Long master dies
- Robust - designed for harsh environments
- Low noise level
- Easy die set-up with ergonomic gun
- Metallic guard for the set stop
- Separated crimping head allowing flexible workshop arrangements
- Optional calliper on SCE & SCS panel

TECHNICAL SPECIFICATIONS

OPTIONAL

CAPACITY*	MOTOR
Industrial: 4" & 6"	5.5 kW
CRIMP RANGE	VOLTAGES
4 - 180 mm (0.157 - 7.087")	220/240 V, 3Ph, 50 Hz
CRIMP FORCE	380/415 V, 3Ph, 50 Hz
450 t	208/240 V, 3Ph, 60 Hz
OPENING WITH DIES	380/415 V, 3Ph, 60 Hz
+70 mm (+2.755")	DIMENSIONS
COMPLETE OPENING	830 x 775 x 1450 mm
230 mm (9.055")	(33 x 31 x 57")
MASTER DIE LENGTH	PACKAGING
125 mm (4.921")	1120 x 1020 x 1770 mm
STANDARD DIES	(44 x 40 x 70")
15, 18, 21, 24, 27, 30, 33, 36, 39, 42, 45, 48, 51, 57, 62, 66, 70, 73, 76; Extra die sets: up to 180 mm; Die sizes available on request	NET WEIGHT
	450 kg (992 lb)



Die Storage Panel



Die Storage Table



Quick Change Gun



Marking Dies



Aluminium Quick Change Gun



Die Sets for Brake & Air Conditioning Hoses

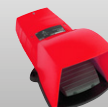

Electrical Footswitch

*Indicative capacities depending on hose and fitting type

MS 450

8" HOSE CRIMPER



KEY FEATURES

High crimping force

Large opening for hoses up to 8" with #150 flanges

Bottom master die is fixed for ease of crimping large hoses

Diameter adjustment is controlled by a numerical vernier and pressure gauge (no electronics)

STANDARD



SCS Safe Crimp System

TECHNICAL SPECIFICATIONS

CAPACITY*

Industrial: 8"

MAX CRIMPING DIAMETER

300 mm (11.811")
(with special dies)

CRIMP FORCE

400 t

OPENING WITH DIES

+ 125mm (4.921")

COMPLETE OPENING

350 mm (13.779")

MAXIMUM DIE LENGTH

140 mm (5.512")

GROSS WEIGHT

2900 kg (6393 lb)

TECHNICAL FEATURES

-Die sizes available upon request

OPTIONAL



Aluminium Quick Change Gun



Quick Change Gun



Electrical Footswitch



Mirror



Back View Camera

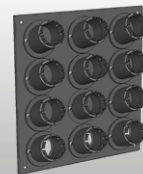

Die Storage Panel

*Indicative capacities depending on hose and fitting type

MS 550/MS 550-16

XXL WORKSHOP



KEY FEATURES

- Very large opening
- Fixed bottom die
- Long dies available
- High crimping force
- Symmetric machine
- Low working height
- Ergonomic
- Safe Crimp System (SCS)
- Step crimping capability with SCS

STANDARD



SCS Safe Crimp System



Die Storage

TECHNICAL SPECIFICATIONS

	XL CRIMP 550	XL CRIMP 550-16
CAPACITY*	Industrial: 12"	Industrial: 16"
CRIMP FORCE	550 t	550 t
COMPLETE OPENING	490 mm (19.291")	660 mm (25.984")
OPENING WITH DIES	+130 mm (+5.118 ")	+160 mm (6.299")
MASTER DIE LENGTH	200 mm (7.874")	200 mm (7.874")
MOTOR	5.5 kW	5.5 kW
VOLTAGES	230 V, 3 Ph 400 V, 4 Ph	230 V, 3 Ph 400 V, 4 Ph
MACHINE DIMENSIONS	1300 x 1050 x 2230 mm (35 x 41 x 88")	1450 x 1100 x 2300 mm (57 x 43 x 91")
POWER PACK DIMENSIONS	800 x 790 x 1650 mm (31 x 31 x 65")	800 x 790 x 1650 mm (31 x 31 x 65")
MACHINE WEIGHT	4000 kg (8818 lb)	4300 kg (9480 lb)
POWER PACK WEIGHT	500 kg (1102 lb)	500 kg (1102 lb)
TECHNICAL FEATURES	Die sizes available upon request	

*Indicative capacities depending on hose and fitting type

ACCESSORIES AND TOOLS

SAFE CRIMP (SC) SMART CONTROL PANEL (WITH OPTIONAL BLUETOOTH)

A basic smart control panel, which includes maintenance functions essential for keeping the machine in good condition.

Maintenance functions include:

- **2 Counters:** 1 daily counter and 1 machine cycle counter
- **3 LED Indicator Lights:** 1 for daily maintenance, 1 for advanced maintenance and 1 for expert maintenance
- **Semi-automatic function:** The semi-automatic opening is ideal for serial assemblies as it can be adjusted specifically to allow the fitting to pass through the dies with minimal clearance, saving energy by reducing the cycle time.



SAFE CRIMP ELECTRICAL PANEL (SCE) (WITH OPTIONAL BLUETOOTH)

A modern touch screen with electronic buttons, which includes maintenance functions essential for keeping the machine in good condition.

Maintenance functions include:

- **Functions of the Safe Crimp Panel**
- **Electronic micrometer** with the ability to save up to 75 configurations and 25 die sets, plus automatic die selection
- **Calliper option available**



ACCESSORIES AND TOOLS

SAFE CRIMP SYSTEM



Benefits of Safe Crimp System control for hose assembly activity:

- Friendly and easy setting of crimping parameters including:
 - ✓ Pre-set of crimp \emptyset calibration to compensate ferrule elastic rebound
 - ✓ Reminder of dies to be used
 - ✓ Easy automatic opening setting
- Storage of recurrent and customised crimp recipes: favourite crimp assemblies:
 - ✓ Short cuts for faster setting
 - ✓ No crimp \emptyset re-adjusting
 - ✓ Possibility to download your customised recipes by USB port and save on separate computer (CSV file)
- Production counter for batch quantity control:
 - ✓ Quality monitoring by: Automatic crimp \emptyset check (Only available on 7" screen)
 - ✓ Continuous crimp pressure measurement (Option on 4.5" screen)
 - ✓ Crimping pressure and count control for mistake proofing assembly (Option 4.5" screen)
- Operator identification (Log in / log out)
- Maintenance Warnings
- Calliper option available

S TEST BENCH 2000 L

TEST BENCH, PROOF PRESSURE & CERTIFY
STAND TYPE MACHINE

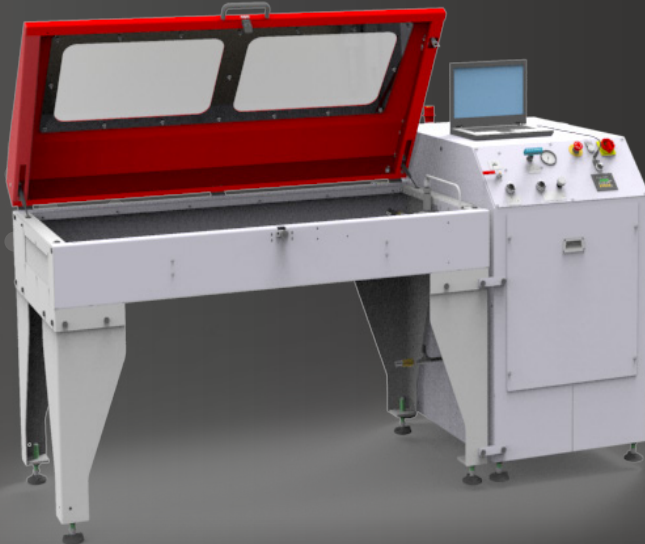

Model shown L (small tank)

KEY FEATURES

- Easy to use and robust
- Safe: Steel Compartment, polycarbonate transparent window and metal mesh
- Large testing area for up to 6 hoses
- Pallet loading with a forklift
- Variable pressure up to 2000 bar

STANDARD

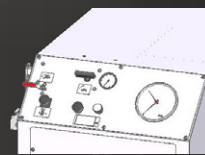

Power Unit M



Power Unit E

TECHNICAL SPECIFICATIONS

INDICATIVE CAPACITY

1200 mm (48")

HOSE CONNECTION

6 maximum

AIR CONSUMPTION

1000 L/min

OPENING/CLOSING TIME

10-14 seconds

MAX PRESSURE

2000 bar (29000 psi)

INNER TANK CAPACITY

1700 x 790 x 200 mm
(67 x 31 x 8")

DIMENSIONS (PANEL)

700 x 1200 x 1220 mm
(28 x 47 x 48")

PACKAGING (TANK)

1600 x 1200 x 1280 mm
(63 x 47 x 50")

PACKAGING (PANEL)

1000 x 1200 x 1280 mm
(39 x 47 x 50")

WEIGHT

430 kg (948 lb)

NET WEIGHT

500 kg (1102 lb)

TECHNICAL FEATURES

-Minimum compressed air input 8.5 bar (123 psi)

FEATURES AND OPTIONS

DISPLAY FEATURES

- M** Gauge measurement display
- E** Numerical measurement display with USB connection for computer report and light

FURTHER OPTIONS

- Autonomous filling pump
- Air blowing system for both models

S TEST BENCH 2000 XL E / ISD

TEST BENCH, PROOF PRESSURE & CERTIFY
STAND TYPE MACHINE



Model shown XL ISD

KEY FEATURES

Easy to use and robust

Safe: Steel Compartment, polycarbonate transparent window and metal mesh

Large testing area for up to 6 hoses

Pallet loading with a forklift

Variable pressure up to 2000 bar

TECHNICAL SPECIFICATIONS

INDICATIVE CAPACITY

1200 mm (48")

HOSE CONNECTION

6 maximum

AIR CONSUMPTION

1000 L/min

OPENING/CLOSING TIME

10-14 seconds

MAX PRESSURE

2000 bar (29000 psi)

INNER TANK CAPACITY

1400 x 900 x 600 mm
(55 x 35 x 24")

DIMENSIONS (PANEL)

700 x 1200 x 1220 mm
(28 x 47 x 48")

PACKAGING (TANK)

1600 x 1200 x 1280 mm

(63 x 47 x 50")

PACKAGING (PANEL)

1000 x 1200 x 1280 mm

(39 x 47 x 50")

WEIGHT

500 kg (1102 lb)

NET WEIGHT

600 kg (1323 lb)

TECHNICAL FEATURES

-Minimum compressed air input 8.5 bar (123 psi)
-Minimum test pressure 250 bar (3626 psi), with low pressure option 50 bar (725 psi) (only for XL ISD)

FEATURES AND OPTIONS

STANDARD OPTIONS

XL ISD:

- Light included
- Touch screen panel
- Printer
- Optional low pressure pump

XL E:

- Light included
- Numerical measurement display with USB connection for computer report.

FURTHER OPTIONS

- Autonomous filling pump
- Air blowing system for both models

TUBE APPLICATIONS



POSSIBLE APPLICATIONS

ECO VERSION - after-market manufacturers

PRO VERSION - OEM manufacturers



Tube stacking



Tube reduction before drawing



Assembling



Geometrical deformation



Calibration



Insulator



Cement Rods

Activities:
Greenhouse, scaffolding, urban furniture, playground equipment, hand rails, mechanical construction, furniture, etc.

AVAILABLE OPTIONS



Mechanical Stop*

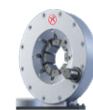

Crimp Heads

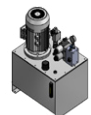

Special Hydraulic Power Pack



Oil Cooling System



Foot Pedal



Central Greasing System



Computer**

*Accuracy and repeatability optimized

**Pressure and diameters controls, data storage to save recipes, assembly by step, alert maintenance

TUBCRIMP 108 ECO



KEY FEATURES

- Compact
- Low-noise technology
- Easy adjustment
- Visibility
- Ergonomics
- Rapid change of tools
- Smart control panel
- Radial movement
- Precise positioning of the tools

TECHNICAL SPECIFICATIONS

CRIMP RANGE

4 - 66 mm (0.157 - 2.598")

CRIMP FORCE

130 t

COMPLETE OPENING

108 mm (4.252")

OPENING WITH DIES

+28 mm (1.102")

MASTER DIE LENGTH

104 mm (4.094")

DIAMETER WITH CLOSED MASTER DIES

80 mm (3.150")

MOTOR

4 kW

PUMP FLOW

9 L/min

CYCLE TIME

10 s

MAX WORKING PRESSURE

280 bar (4061 psi)

VOLUME RATIO OF CHAMBERS

8

NOISE LEVEL

68 dB A

DIMENSIONS

765 x 400 x 750 mm
(30 x 16 x 30")

WEIGHT (WITH OIL)

165 kg (364 lb)

OPTIONAL



Special Die Sets
(upon request)

TUBCRIMP 158 ECO



KEY FEATURES

- Compact
- Low-noise technology
- Easy adjustment
- Visibility
- Ergonomics
- Rapid change of tools
- Smart control panel
- Radial movement
- Precise positioning of the tools

TECHNICAL SPECIFICATIONS

CRIMP RANGE

4 - 110 mm (0.157 - 4.331")

CRIMP FORCE

190 t

COMPLETE OPENING

158 mm (6.220")

OPENING WITH DIES

+28 mm (1.102")

MASTER DIE LENGTH

125 mm (4.921")

DIAMETER WITH CLOSED MASTER DIES

130 mm (5.118")

MOTOR

4 kW

PUMP FLOW

9 L/min

CYCLE TIME

15 s

MAX WORKING PRESSURE

280 bar (4061 psi)

VOLUME RATIO OF CHAMBERS

9

NOISE LEVEL

68 dB A

DIMENSIONS

765 x 400 x 750 mm
(30 x 16 x 30")

WEIGHT (WITH OIL)

262 kg (578 lb)

OPTIONAL



Special Die Sets
(upon request)

TUBCRIMP 108 PRO

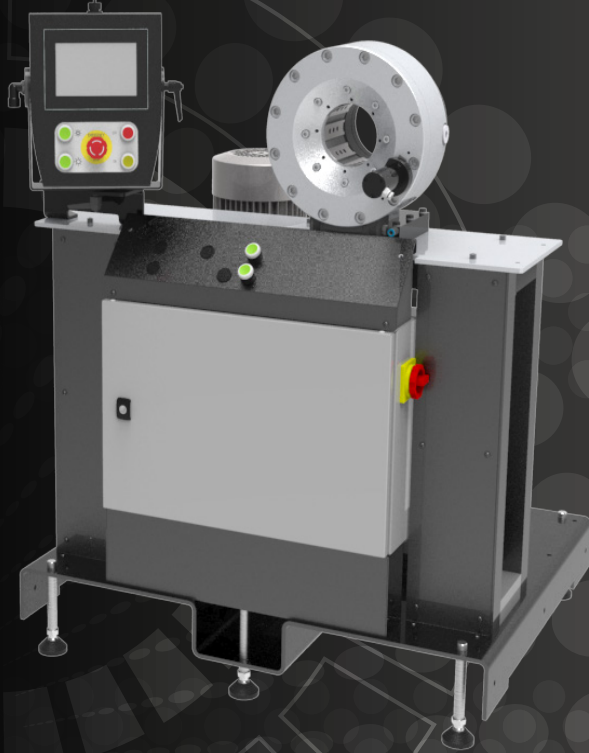

KEY FEATURES

- Computer with pressure control
- Foot pedal included
- Silent pump
- Radial movement
- Precise positioning of the tools
- Rapid change of tools

STANDARD



Electrical Footswitch

TECHNICAL SPECIFICATIONS

CRIMP RANGE	CYCLE TIME
4 - 66 mm (0.157 - 2.598")	6 s
CRIMP FORCE	MAX WORKING PRESSURE
115 t	250 bar (3626 psi)
COMPLETE OPENING	VOLUME RATIO OF CHAMBERS
108 mm (4.252")	8
OPENING WITH DIES	NOISE LEVEL
+28 mm (1.102")	65 dB A
MASTER DIE LENGTH	DIMENSIONS
104 mm (4.094")	1000 x 840 x 1200 mm (39 x 33 x 47")
DIAMETER WITH CLOSED MASTER DIES	WEIGHT (WITH OIL)
80 mm (3.150")	410 kg (904 lb)
MOTOR	
5.5 kW	
PUMP FLOW	
16 L/min	

OPTIONAL



Special Die Sets
(upon request)

TUBCRIMP 158 PRO

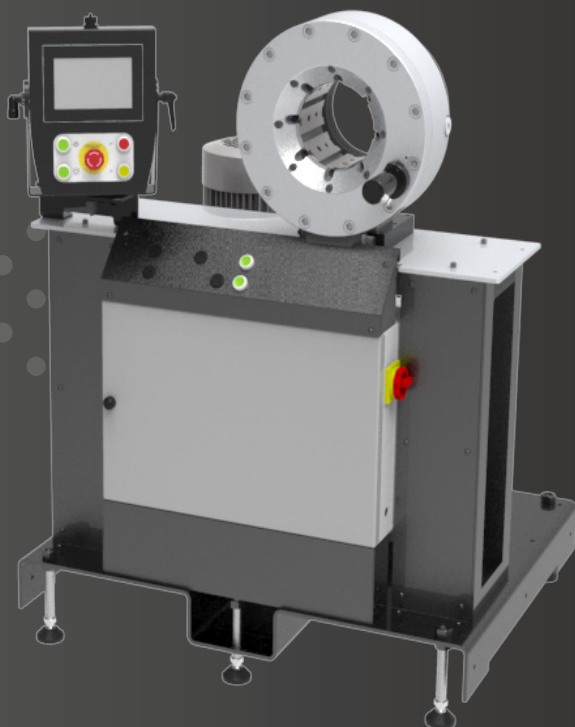

KEY FEATURES

- Computer with pressure control
- Foot pedal included
- Silent pump
- Radial movement
- Precise positioning of the tools
- Rapid change of tools

STANDARD



Electrical Footswitch

TECHNICAL SPECIFICATIONS

CRIMP RANGE

4 - 110 mm (0.157 - 4.331")

CRIMP FORCE

170 t

COMPLETE OPENING

156 mm (6.141")

OPENING WITH DIES

+28 mm (1.102")

MASTER DIE LENGTH

125 mm (4.921")

DIAMETER WITH CLOSED MASTER DIES

130 mm (5.118")

MOTOR

5.5 kW

PUMP FLOW

16 L/min

CYCLE TIME

9 s

MAX WORKING PRESSURE

250 bar (3626 psi)

VOLUME RATIO OF CHAMBERS

9

NOISE LEVEL

65 dB A

DIMENSIONS

1000 x 840 x 1200 mm
(39 x 33 x 47")

WEIGHT (WITH OIL)

450 kg (992 lb)

OPTIONAL



Special Die Sets
(upon request)

TUBCRIMP 260 HP

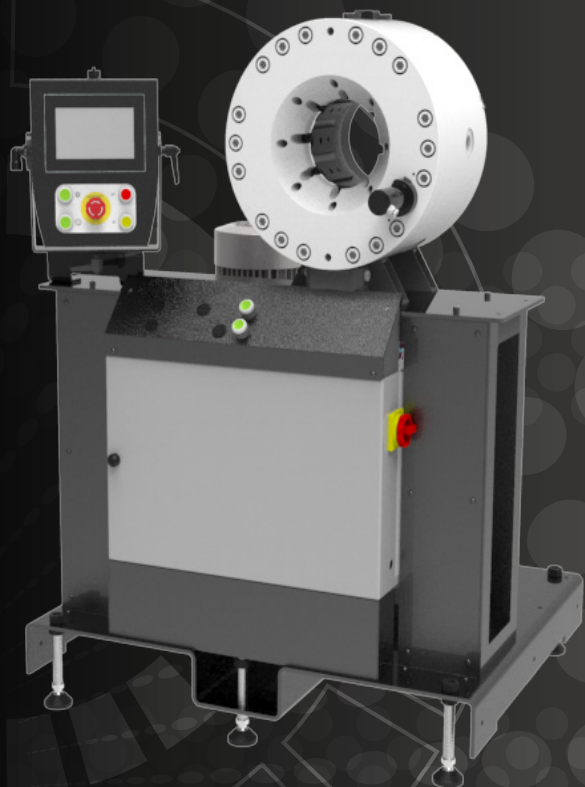

KEY FEATURES

- Computer with pressure control
- Foot pedal included
- Silent pump
- Radial movement
- Precise positioning of the tools
- Rapid change of tools

STANDARD



Electrical Footswitch

TECHNICAL SPECIFICATIONS

OPTIONAL

CRIMP RANGE	CYCLE TIME
4 - 110 mm (0.157 - 4.331")	14 s
CRIMP FORCE	MAX WORKING PRESSURE
260 t	250 bar (3626 psi)
COMPLETE OPENING	VOLUME RATIO OF CHAMBERS
156 mm (6.142")	6.8
OPENING WITH DIES	NOISE LEVEL
+26 mm (1.024")	65 dB A
MASTER DIE LENGTH	DIMENSIONS
125 mm (4.921")	1000 x 840 x 1300 mm (39 x 33 x 51")
DIAMETER WITH CLOSED MASTER DIES	WEIGHT (WITH OIL)
130 mm (5.118")	600 kg (1323 lb)
MOTOR	
5.5 kW	
PUMP FLOW	
16 L/min	

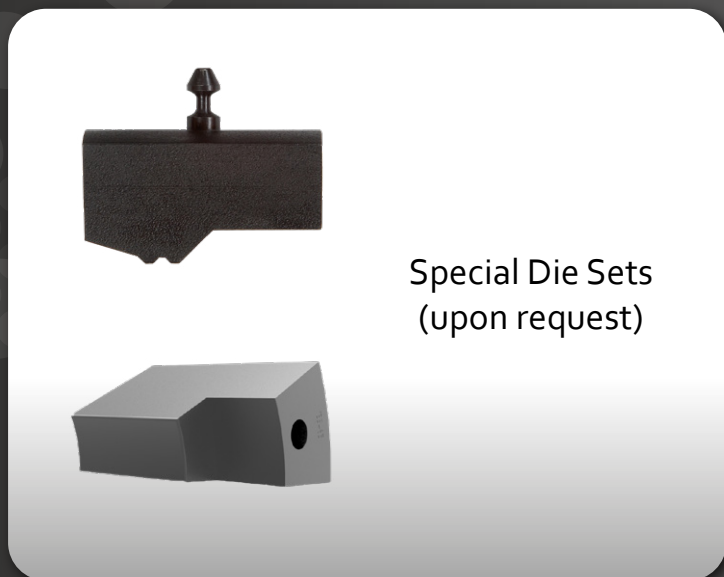

Special Die Sets
(upon request)

TUBCRIMP 660 HP



KEY FEATURES

- Computer with pressure control
- Foot pedal included
- Silent pump
- Radial movement
- Precise positioning of the tools
- Crimp strength
- Long master dies

STANDARD



Electrical Footswitch

TECHNICAL SPECIFICATIONS

CRIMP RANGE	CYCLE TIME
10 - 180 mm (0.394 - 7.087")	30 s
CRIMP FORCE	MAX WORKING PRESSURE
660 t	320 bar (4641 psi)
COMPLETE OPENING	VOLUME RATIO OF CHAMBERS
225 mm (8.858")	2.95
OPENING WITH DIES	NOISE LEVEL
+25 mm (0.984")	66 dB A
MASTER DIE LENGTH	DIMENSIONS
230 mm (9.055")	1000 x 840 x 1370 mm (39 x 33 x 54")
DIAMETER WITH CLOSED MASTER DIES	WEIGHT (WITH OIL)
200 mm (7.874")	940 kg (2072 lb)
MOTOR	
5.5 kW	
PUMP FLOW	
16 L/min	

OPTIONAL

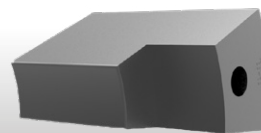

Special Die Sets
(upon request)

TUBCRIMP 1700 HP

KEY FEATURES

- Foot pedal included
- Silent pump
- Crimp strength
- Long master dies
- Through passing head



TECHNICAL SPECIFICATIONS

OPTIONAL

CRIMP RANGE

40 - 315 mm (1.575- 12.402")

CRIMP FORCE

1700 t

COMPLETE OPENING

360 mm (14.173")

OPENING WITH DIES

+30 mm (1.181")

MASTER DIE LENGTH

275 mm (10.827")

DIAMETER WITH CLOSED MASTER DIES

310 mm (12.205")

MOTOR

5.5 kW

PUMP FLOW

16 L/min

CYCLE TIME

33 s

MAX WORKING PRESSURE

320 bar (4641 psi)

VOLUME RATIO OF CHAMBERS

1.26

NOISE LEVEL

66 dB A

MACHINE DIMENSIONS

960 x 1400 x 1400 mm
(38 x 55 x 55")

POWERPACK DIMENSIONS

600 x 1950 x 1200 mm
(24 x 77 x 47")

WEIGHT (WITH OIL)

200 kg (441 lb)

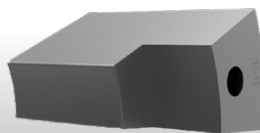

Special Die Sets
(upon request)

AUTOMOTIVE APPLICATIONS



POSSIBLE APPLICATIONS



Air Spring



Part calibration - shock absorbers, pulleys



A/C, brake hoses, control cables



Automotive pipe



Airbag inflators

AVAILABLE OPTIONS



Mechanical Set Stop

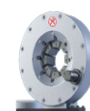

Crimp Heads

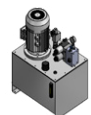

Special Hydraulic Power Pack



Foot Pedal



Central Greasing System

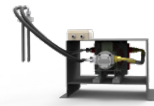

Oil Cooling System



Computer**

*Accuracy and repeatability optimized

**Pressure and diameters controls, data storage to save recipes, assembly by step, alert maintenance

N CRIMP 70/80

PEP 108/158
EXPERT SERVICE LINE

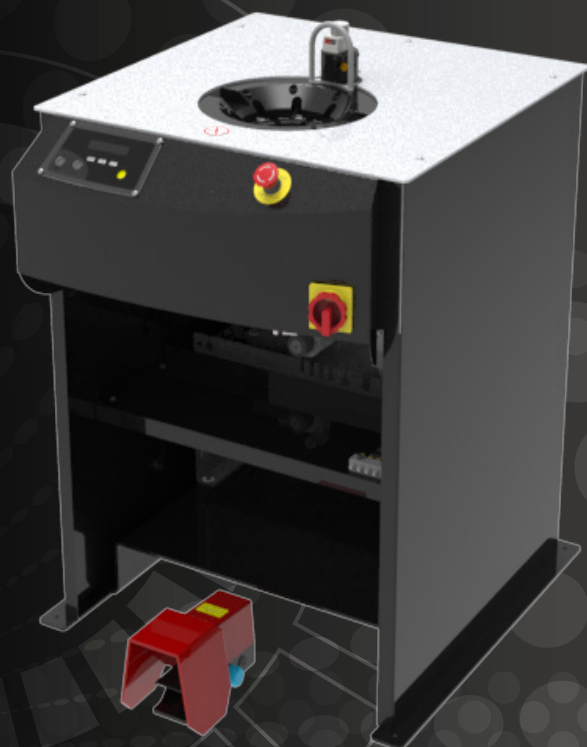

KEY FEATURES

- Easy to use
- Accurate
- Robust die holder system
- Automatic opening
- High speed
- Large opening
- Large capacity
- Available with 6 master dies
- Easy and precise positioning of fitting support

STANDARD



Ergonomic Micrometer

TECHNICAL SPECIFICATIONS

	N CRIMP 70	N CRIMP 80
CAPACITY*	1 1/2"	3"
CRIMP RANGE	4 - 60 mm (0.157 - 2.362")	4 - 110 mm (0.157 - 4.331")
CRIMP FORCE	70 t	80 t
COMPLETE OPENING	108 mm (4.252")	156 mm (6.142")
OPENING WITH DIES	+28 mm (1.102")	+28 mm (1.102")
MASTER DIE LENGTH	100 mm (3.937")	125 mm (4.921")
MOTOR*	3 kW	4 kW
VOLTAGES	230V, 3Ph 400V, 3Ph	230V, 3Ph 400V, 3Ph
DIMENSIONS	724 x 950 x 11700 mm (29 x 37 x 46")	724 x 950 x 11700 mm (29 x 37 x 46")
PACKAGING	1120 x 1020 x 1770 mm (44 x 40 x 70")	1120 x 1020 x 1770 mm (44 x 40 x 70")
NET WEIGHT	270 kg (595 lb)	340 kg (750 lb)

OPTIONAL



Electrical Footswitch



Automatic Central Greasing Pump

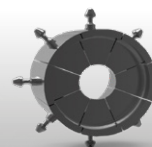

Pre-Crimping Die Sets

- For nut crimping die sets see page 87

*Indicative capacities depending on the hose and fitting type

AUTOCRIMP 106/108/158 PRO V

AIRBAG, PART CALIBRATION,
SHOCK ABSORBERS, PULLEYS

KEY FEATURES



Autocrimp 106	Autocrimp 108/158 PRO V
<ul style="list-style-type: none"> • Pneumatic or hydraulic power • Compact head for easy integration into a production line • Robust components for heavy series • Low maintenance • High Cpk / Cmk performances 	<ul style="list-style-type: none"> • Accuracy • Mechanical set stop • Robust • Silent pump • Radial movement • Precise positioning of the tools • Rapid change of tools • Light barrier

OPTIONAL



TECHNICAL SPECIFICATIONS

	AUTOCRIMP 106	AUTOCRIMP 108	AUTOCRIMP 158 PRO V
CRIMP RANGE	4 - 66 mm (0.157 - 2.598")	4 - 66 mm (0.157 - 2.598")	4 - 110 mm (0.157 - 4.331")
CRIMP FORCE	40 t	115 t	170 t
COMPLETE OPENING	108 mm (4.252")	108 mm (4.252")	156 mm (6.142")
OPENING WITH DIES	+28 mm (1.102")	+28 mm (1.102")	+28 mm (1.102")
MASTER DIE LENGTH	104 mm (4.094")	104 mm (4.094")	125 mm (4.921")
DIAMETER WITH CLOSED MASTER DIES	80 mm (3.150")	80 mm (3.150")	130 mm (5.118")
MOTOR*	4 kW	4 kW	5.5 kW
PUMP FLOW*	9 L/min	9 L/min	16 L/min
CYCLE TIME*	2 - 10 s	10 s	9 s
MAX WORKING PRESSURE	160 bar (2321 psi)	250 bar (3626 psi)	250 bar (3626 psi)
VOLUME RATIO OF CHAMBERS	-	8	9
NOISE LEVEL	65 dB A	65 dB A	65 dB A

* Pneumatic or hydraulic power according to customer's specifications

AUTOCRIMP 8.25 PRO

TO8 25
A/C, COMPOSITE HOSES

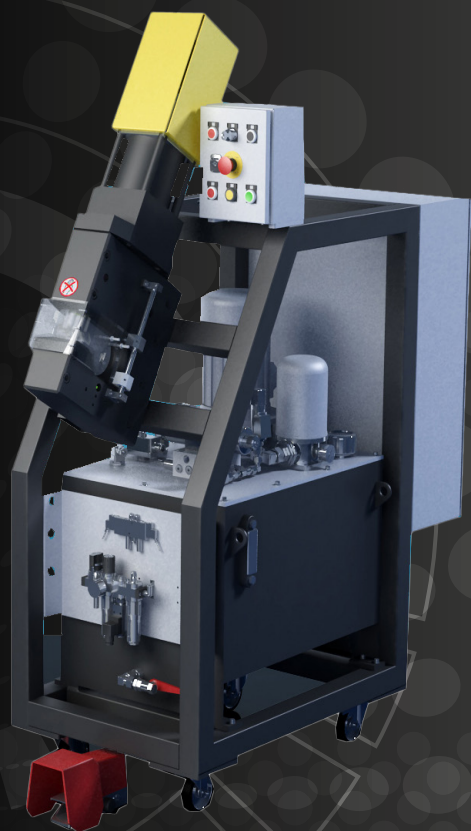

KEY FEATURES

- Ideal for composite (rubber hose and tube) assemblies
- High Cpk / Cmk performances
- Slim design (120 mm)
- Designed for intensive OEM production
- Possibility to order head only for integration into fully automated production line

TECHNICAL SPECIFICATIONS

OPTIONAL

CRIMP RANGE

4 - 40 mm (0.157 - 1.575")

CRIMP FORCE

20 t

COMPLETE OPENING

55 mm (2.165")

MAX CRIMPING STROKE

10 mm (0.394")

MASTER DIE LENGTH

50 mm (1.969")

DIAMETER WITH CLOSED MASTER DIES

50 mm (1.969")

MOTOR

3 kW

PUMP FLOW

30 L/min

CYCLE TIME

3.6 s

MAX WORKING PRESSURE

160 bar (2321 psi)

VOLUME RATIO OF CHAMBERS

2

NOISE LEVEL

65 dB A



Special Die Sets
(upon request)

TO8 25 HEAD

ASSEMBLY HEAD
A/C, COMPOSITE HOSES

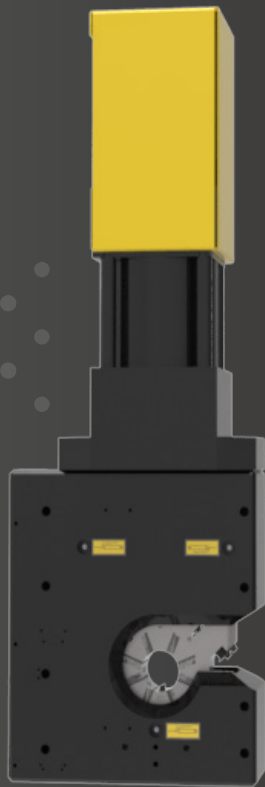

KEY FEATURES

- Ideal for composite (rubber hose and tube) assemblies
- High Cpk / Cmk performances
- Slim design (120 mm)
- Designed for intensive OEM production
- Possibility to order head only for integration into fully automated production line

TECHNICAL SPECIFICATIONS

CRIMP RANGE	PUMP FLOW
4 - 40 mm (0.157 - 1.575")	30 L MAX
CRIMP FORCE	CYCLE TIME
20 t	3.6 s / 30L min
COMPLETE OPENING	MAX WORKING PRESSURE
55 mm (2.165")	160 bar (2321 psi)
MAX CRIMPING STROKE	VOLUME RATIO OF CHAMBERS
10 mm (0.394")	2
MASTER DIE LENGTH	
50 mm (1.969")	
DIAMETER WITH CLOSED MASTER DIES	
50 mm (1.969")	

OPTIONAL

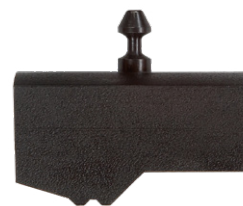

Special Die Sets
(upon request)

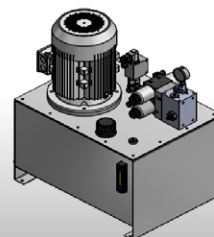

Special Hydraulic
Power Pack

POP 106 - AUTOCRIMP 106-108-158

**ASSEMBLY HEAD
AIRBAG**



KEY FEATURES

- Pneumatic or hydraulic power
- Compact head for easy integration into a production line
- Robust components for heavy series
- Low maintenance
- High Cpk / Cmk performances

TECHNICAL SPECIFICATIONS

CRIMP RANGE	DIAMETER WITH CLOSED MASTER DIES
4 - 66 mm (0.157 - 2.598")	80 mm (3.150")
CRIMP FORCE	POWER SOURCE
40 t	Hydraulic or pneumatic
COMPLETE OPENING	CYCLE TIME
108 mm (4.252")	2 - 10 s
OPENING WITH DIES	MAX WORKING PRESSURE
+28 mm (1.102")	160 bar (2321 psi)
MASTER DIE LENGTH	
104 mm (4.094")	

OPTIONAL



Special Die Sets
(upon request)

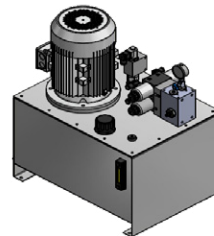

Special Hydraulic
Power Pack

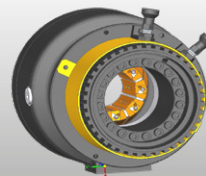

Mechanical Set
Stop

MHP 80

PG. 21

DESCRIPTION	N°	CRIMP RANGE
DIE SET N. 06 - LENGTH 56 MM	6	06-08
DIE SET N. 08 - LENGTH 56 MM	8	08-10
DIE SET N. 10 - LENGTH 56 MM	10	10-12
DIE SET N. 12 - LENGTH 56 MM	12	12-15
DIE SET N. 15 - LENGTH 56 MM	15	15-18
DIE SET N. 18 - LENGTH 56 MM	18	18-21
DIE SET N. 21 - LENGTH 56 MM	21	21-24
DIE SET N. 24 - LENGTH 56 MM	24	24-27
DIE SET N. 27 - LENGTH 56 MM	27	27-30
DIE SET N. 30 - LENGTH 56 MM	30	30-43
KIT 6 DIES MHP80 (N.15 TO N.30)	-	-

MHP 110

PG. 22

DESCRIPTION	N°	CRIMP RANGE
DIE SET N. 06 - LENGTH 56 MM	6	06-08
DIE SET N. 08 - LENGTH 56 MM	8	08-10
DIE SET N. 10 - LENGTH 56 MM	10	10-12
DIE SET N. 12 - LENGTH 56 MM	12	12-15
DIE SET N. 15 - LENGTH 56 MM	15	15-18
DIE SET N. 18 - LENGTH 56 MM	18	18-21
DIE SET N. 21 - LENGTH 56 MM	21	21-24
DIE SET N. 24 - LENGTH 56 MM	24	24-27
DIE SET N. 27 - LENGTH 56 MM	27	27-30
DIE SET N. 30 - LENGTH 56 MM	30	30-39
KIT 6 DIES MHP110 (N.15 TO N.30)	-	-

MHP 137

PG. 23

DESCRIPTION	N°	CRIMP RANGE
DIE SET N. 4 - LENGTH 56 MM	4	04-05
DIE SET N. 6 - LENGTH 56 MM	6	06-07
DIE SET N. 7 - LENGTH 56 MM	7	07-08
DIE SET N. 8 - LENGTH 56 MM	8	08-10
DIE SET N. 9 - LENGTH 56 MM	9	09-10
DIE SET N. 10 - LENGTH 56 MM	10	10-12
DIE SET N. 12 - LENGTH 56 MM	12	12-15
DIE SET N. 14 - LENGTH 56 MM	14	14-15
DIE SET N. 15 - LENGTH 56 MM	15	15-18
DIE SET N. 17 - LENGTH 56 MM	17	17-18
DIE SET N. 18 - LENGTH 56 MM	18	18-21
DIE SET N. 20 - LENGTH 56 MM	20	20-21
DIE SET N. 21 - LENGTH 56 MM	21	21-24
DIE SET N. 24 - LENGTH 56 MM	24	24-27
DIE SET N. 27 - LENGTH 56 MM	27	27-30
DIE SET N. 30 - LENGTH 56 MM	30	30-33
DIE SET N. 33 - LENGTH 70 MM	33	33-36
DIE SET N. 36 - LENGTH 75 MM	36	36-39
DIE SET N. 39 - LENGTH 70 MM	39	39-42
DIE SET N. 42 - LENGTH 70 MM	42	42-45
DIE SET N. 45 - LENGTH 70 MM	45	45-48
DIE SET N. 48 - LENGTH 70 MM	48	48-51
DIE SET N. 51 - LENGTH 75 MM	51	51-57
KIT 4 DIES MHP137 (N.15 TO N.33)	-	-
KIT 5 DIES MHP137 (N.15 TO N.39)	-	-
KIT 6 DIES MHP137 (N.15 TO N.39)	-	-
KIT 7 DIES MHP137 (N.15 TO N.39)	-	-
KIT 9 DIES MHP137 (N.15 TO N.45)	-	-
KIT 9 DIES MHP137 (N.15 TO N.48)	-	-
KIT 10 DIES MHP137 (N.15 TO N.48)	-	-
KIT 13 DIES HCRIMP137 (N.15 TO N.51)	-	-

MRB 137 EVO R

PG. 24

DESCRIPTION	N°	CRIMP RANGE
DIE SET N. 4 - LENGTH 56 MM	4	04-05
DIE SET N. 6 - LENGTH 56 MM	6	06-07
DIE SET N. 7 - LENGTH 56 MM	7	07-08
DIE SET N. 8 - LENGTH 56 MM	8	08-10
DIE SET N. 9 - LENGTH 56 MM	9	09-10
DIE SET N. 10 - LENGTH 56 MM	10	10-12
DIE SET N. 12 - LENGTH 56 MM	12	12-15
DIE SET N. 14 - LENGTH 56 MM	14	14-15
DIE SET N. 15 - LENGTH 56 MM	15	15-18
DIE SET N. 17 - LENGTH 56 MM	17	17-18
DIE SET N. 18 - LENGTH 56 MM	18	18-21
DIE SET N. 20 - LENGTH 56 MM	20	20-21
DIE SET N. 21 - LENGTH 56 MM	21	21-24
DIE SET N. 24 - LENGTH 56 MM	24	24-27
DIE SET N. 27 - LENGTH 56 MM	27	27-30
DIE SET N. 30 - LENGTH 56 MM	30	30-33
DIE SET N. 33 - LENGTH 70 MM	33	33-36
DIE SET N. 36 - LENGTH 75 MM	36	36-39
DIE SET N. 39 - LENGTH 70 MM	39	39-42
DIE SET N. 42 - LENGTH 70 MM	42	42-45
DIE SET N. 45 - LENGTH 70 MM	45	45-48
DIE SET N. 48 - LENGTH 70 MM	48	48-51
DIE SET N. 51 - LENGTH 75 MM	51	51-57
KIT 4 DIES MRB137EVOR (N.15 TO N.33)	-	-
KIT 5 DIES MRB137EVOR (N.15 TO N.39)	-	-
KIT 6 DIES MRB137EVOR (N.15 TO N.39)	-	-
KIT 7 DIES MRB137EVOR (N.15 TO N.39)	-	-
KIT 9 DIES MRB137EVOR (N.15 TO N.45)	-	-
KIT 9 DIES MRB137EVOR (N.15 TO N.48)	-	-
KIT 10 DIES MRB137EVOR (N.15 TO N.48)	-	-
KIT 13 DIES MRB137EVOR (N.15 TO N.51)	-	-

MB 137 EVO

PG. 25

DESCRIPTION	N°	CRIMP RANGE
DIE SET N. 4 - LENGTH 56 MM	4	04-05
DIE SET N. 6 - LENGTH 56 MM	6	06-07
DIE SET N. 7 - LENGTH 56 MM	7	07-08
DIE SET N. 9 - LENGTH 56 MM	9	09-10
DIE SET N. 8 - LENGTH 56 MM	8	08-10
DIE SET N. 10 - LENGTH 56 MM	10	10-12
DIE SET N. 12 - LENGTH 56 MM	12	12-15
DIE SET N. 14 - LENGTH 56 MM	14	14-15
DIE SET N. 15 - LENGTH 56 MM	15	15-18
DIE SET N. 17 - LENGTH 56 MM	17	17-18
DIE SET N. 18 - LENGTH 56 MM	18	18-21
DIE SET N. 20 - LENGTH 56 MM	20	20-21
DIE SET N. 21 - LENGTH 56 MM	21	21-24
DIE SET N. 24 - LENGTH 56 MM	24	24-27
DIE SET N. 27 - LENGTH 56 MM	27	27-30
DIE SET N. 30 - LENGTH 56 MM	30	30-33
DIE SET N. 33 - LENGTH 70 MM	33	33-36
DIE SET N. 36 - LENGTH 75 MM	36	36-39
DIE SET N. 39 - LENGTH 70 MM	39	39-42
DIE SET N. 42 - LENGTH 70 MM	42	42-45
DIE SET N. 45 - LENGTH 70 MM	45	45-48
DIE SET N. 48 - LENGTH 70 MM	48	48-51
DIE SET N. 51 - LENGTH 75 MM	51	51-57
KIT 4 DIES MB137EVO (N.15 TO N.33)	-	-
KIT 5 DIES MB137EVO (N.15 TO N.39)	-	-
KIT 6 DIES MB137EVO (N.15 TO N.39)	-	-
KIT 7 DIES MB137EVO (N.15 TO N.39)	-	-
KIT 9 DIES MB137EVO (N.15 TO N.45)	-	-
KIT 9 DIES MB137EVO (N.15 TO N.48)	-	-
KIT 10 DIES MB137EVO (N.15 TO N.48)	-	-
KIT 13 DIES MB137EVO (N.15 TO N.51)	-	-

MB 240 EVO

PG. 26

DESCRIPTION	N°	CRIMP RANGE
DIE SET N. 4 - LENGTH 56 MM	4	04-05
DIE SET N. 6 - LENGTH 56 MM	6	06-08
DIE SET N. 7 - LENGTH 56 MM	7	07-08
DIE SET N. 8 - LENGTH 56 MM	8	08-09
DIE SET N. 9 - LENGTH 56 MM	9	09-10
DIE SET N. 10 - LENGTH 56 MM	10	10-12
DIE SET N. 12 - LENGTH 56 MM	12	12-15
DIE SET N. 14 - LENGTH 56 MM	14	14-15
DIE SET N. 15 - LENGTH 56 MM	15	15-18
DIE SET N. 17 - LENGTH 56 MM	17	17-18
DIE SET N. 18 - LENGTH 56 MM	18	18-21
DIE SET N. 20 - LENGTH 56 MM	20	20-21
DIE SET N. 21 - LENGTH 56 MM	21	21-24
DIE SET N. 24 - LENGTH 70 MM	24	24-27
DIE SET N. 27 - LENGTH 90 MM	27	27-30
DIE SET N. 30 - LENGTH 90 MM	30	30-33
DIE SET N. 33 - LENGTH 90 MM	33	33-36
DIE SET N. 36 - LENGTH 90 MM	36	36-39
DIE SET N. 39 - LENGTH 90 MM	39	39-42
DIE SET N. 42 - LENGTH 90 MM	42	42-45
DIE SET N. 45 - LENGTH 100 MM	45	45-48
DIE SET N. 48 - LENGTH 100 MM	48	48-51
DIE SET N. 51 - LENGTH 100 MM	51	51-57
DIE SET N. 54 - LENGTH 110 MM	54	54-57
DIE SET N. 57 - LENGTH 100 MM	57	57-62
DIE SET N. 60 - LENGTH 100 MM	60	60-62
DIE SET N. 62 - LENGTH 110 MM	62	62-66
DIE SET N. 66 - LENGTH 100 MM	66	66-70
DIE SET N. 70 - LENGTH 100 MM	70	70-72
DIE SET N. 72 - LENGTH 100 MM	72	72-80
KIT 9 DIES MB240EVO (N.15 TO N.51)	-	-
KIT 11 DIES MB240EVO (N.15 TO N.66)	-	-
KIT 12 DIES MB240EVO (N.15 TO N.66)	-	-
KIT 17 DIES MB240EVO (N.15 TO N.70)	-	-

- REFERENCES IN **BOLD** ARE INCLUDED IN THE STANDARD DIE KIT (ALSO IN **BOLD**)

MB 350 EVO

PG. 27

DESCRIPTION	N°	CRIMP RANGE
DIE SET N. 4 - LENGTH 56 MM	4	04-05
DIE SET N. 6 - LENGTH 56 MM	6	06-08
DIE SET N. 7 - LENGTH 56 MM	7	07-08
DIE SET N. 8 - LENGTH 56 MM	8	08-09
DIE SET N. 9 - LENGTH 56 MM	9	09-10
DIE SET N. 10 - LENGTH 56 MM	10	10-12
DIE SET N. 12 - LENGTH 56 MM	12	12-15
DIE SET N. 14 - LENGTH 56 MM	14	14-15
DIE SET N. 15 - LENGTH 56 MM	15	15-18
DIE SET N. 17 - LENGTH 56 MM	17	17-18
DIE SET N. 18 - LENGTH 56 MM	18	18-21
DIE SET N. 20 - LENGTH 56 MM	20	20-21
DIE SET N. 21 - LENGTH 56 MM	21	21-24
DIE SET N. 24 - LENGTH 70 MM	24	24-27
DIE SET N. 27 - LENGTH 90 MM	27	27-30
DIE SET N. 30 - LENGTH 90 MM	30	30-33
DIE SET N. 33 - LENGTH 90 MM	33	33-36
DIE SET N. 36 - LENGTH 90 MM	36	36-39
DIE SET N. 39 - LENGTH 90 MM	39	39-42
DIE SET N. 42 - LENGTH 90 MM	42	42-45
DIE SET N. 45 - LENGTH 100 MM	45	45-48
DIE SET N. 48 - LENGTH 100 MM	48	48-51
DIE SET N. 51 - LENGTH 110 MM	51	51-57
DIE SET N. 54 - LENGTH 110 MM	54	54-57
DIE SET N. 57 - LENGTH 110 MM	57	57-62
DIE SET N. 60 - LENGTH 110 MM	60	60-62
DIE SET N. 62 - LENGTH 125 MM	62	62-66
DIE SET N. 66 - LENGTH 110 MM	66	66-70
DIE SET N. 66* - LENGTH 125 MM	66*	66-70
DIE SET N. 70 - LENGTH 100 MM	70	70-72
DIE SET N. 70* - LENGTH 125 MM	70*	70-72
DIE SET N. 72 - LENGTH 100 MM	72	72-73
DIE SET N. 73 - LENGTH 125 MM	73	73-76
DIE SET N. 75 - LENGTH 125 MM	75	75-76
DIE SET N. 76 - LENGTH 125 MM	76	76-86
DIE SET N. 80 - LENGTH 125 MM	80	80-86
DIE SET N. 86 - LENGTH 125 MM	86	86-90
DIE SET N. 90 - LENGTH 125 MM	90	90-95
DIE SET N. 95 - LENGTH 125 MM	95	95-105
DIE SET N. 99 - LENGTH 125 MM	99	99-109
DIE SET N. 112 - LENGTH 125 MM	112	112-117
DIE SET N. 117 - LENGTH 125 MM	117	117-122
DIE SET N. 122 - LENGTH 125 MM	122	122-127
KIT 13 DIES MB350EVO/L (N.15 TO N.73)	-	-
KIT 19 DIES MB350EVO/L (N.15 TO N.76)	-	-

- REFERENCES IN BOLD ARE INCLUDED IN THE STANDARD DIE KIT (ALSO IN BOLD)

GOLDENCRIMP 420 EVO

PG. 28

DESCRIPTION	N°	CRIMP RANGE
DIE SET N. 4 - LENGTH 56 MM	4	04-05
DIE SET N. 6 - LENGTH 56 MM	6	06-08
DIE SET N. 7 - LENGTH 56 MM	7	07-08
DIE SET N. 8 - LENGTH 56 MM	8	08-09
DIE SET N. 10 - LENGTH 56 MM	10	10-12
DIE SET N. 12 - LENGTH 56 MM	12	12-15
DIE SET N. 15 - LENGTH 56 MM	15	15-18
DIE SET N. 17 - LENGTH 56 MM	17	17-18
DIE SET N. 18 - LENGTH 56 MM	18	18-21
DIE SET N. 20 - LENGTH 56 MM	20	20-21
DIE SET N. 21 - LENGTH 56 MM	21	21-24
DIE SET N. 24 - LENGTH 70 MM	24	24-27
DIE SET N. 27 - LENGTH 90 MM	27	27-30
DIE SET N. 30 - LENGTH 90 MM	30	30-33
DIE SET N. 33 - LENGTH 90 MM	33	33-36
DIE SET N. 36 - LENGTH 90 MM	36	36-39
DIE SET N. 39 - LENGTH 90 MM	39	39-42
DIE SET N. 42 - LENGTH 90 MM	42	42-45
DIE SET N. 45 - LENGTH 100 MM	45	45-48
DIE SET N. 48 - LENGTH 100 MM	48	48-51
DIE SET N. 51 - LENGTH 110 MM	51	51-57
DIE SET N. 54 - LENGTH 110 MM	54	54-57
DIE SET N. 57 - LENGTH 110 MM	57	57-62
DIE SET N. 60 - LENGTH 110 MM	60	60-62
DIE SET N. 62 - LENGTH 110 MM	62	60-62
DIE SET N. 62* - LENGTH 125 MM	62*	62-66
DIE SET N. 66 - LENGTH 110 MM	66	66-70
DIE SET N. 66* - LENGTH 125 MM	66*	66-70
DIE SET N. 70 - LENGTH 100 MM	70	70-72
DIE SET N. 70* - LENGTH 125 MM	70*	70-72
DIE SET N. 73 - LENGTH 125 MM	73	73-76
DIE SET N. 75 - LENGTH 125 MM	75	75-76
DIE SET N. 76 - LENGTH 125 MM	76	76-86
DIE SET N. 76* - LENGTH 135 MM	76*	76-86
DIE SET N. 80 - LENGTH 125 MM	80	80-82
DIE SET N. 82 - LENGTH 135 MM	82	82-90
DIE SET N. 86 - LENGTH 125 MM	86	86-90
DIE SET N. 86* - LENGTH 150 MM (FOR DIAMONDSPIR 2½")	86*	86-90
DIE SET N. 90 - LENGTH 125 MM	90	90-95
DIE SET N. 95 - LENGTH 125 MM	95	95-105
DIE SET N. 95* - LENGTH 150 MM (FOR DIAMONDSPIR 2½")	95*	95-105
KIT 13 DIE SET GOLDENCRIMP420EVO (15 TO 73)	-	-
KIT 19 DIE SET GOLDENCRIMP420EVO (15 TO 76)	-	-

- REFERENCES IN **BOLD** ARE INCLUDED IN THE STANDARD DIE KIT (ALSO IN **BOLD**)

GOLDENCRIMP 450

PG. 29

DESCRIPTION	N°	CRIMP RANGE
DIE SET N. 4 - LENGTH 56 MM	4	04-05
DIE SET N. 6 - LENGTH 56 MM	6	06-08
DIE SET N. 7 - LENGTH 56 MM	7	07-08
DIE SET N. 8 - LENGTH 56 MM	8	08-09
DIE SET N. 10 - LENGTH 56 MM	10	10-12
DIE SET N. 12 - LENGTH 56 MM	12	12-15
DIE SET N. 15 - LENGTH 56 MM	15	15-18
DIE SET N. 17 - LENGTH 56 MM	17	17-18
DIE SET N. 18 - LENGTH 56 MM	18	18-21
DIE SET N. 20 - LENGTH 56 MM	20	20-21
DIE SET N. 21 - LENGTH 56 MM	21	21-24
DIE SET N. 24 - LENGTH 70 MM	24	24-27
DIE SET N. 27 - LENGTH 90 MM	27	27-30
DIE SET N. 30 - LENGTH 90 MM	30	30-33
DIE SET N. 33 - LENGTH 90 MM	33	33-36
DIE SET N. 36 - LENGTH 90 MM	36	36-39
DIE SET N. 39 - LENGTH 90 MM	39	39-42
DIE SET N. 42 - LENGTH 90 MM	42	42-45
DIE SET N. 45 - LENGTH 100 MM	45	45-48
DIE SET N. 48 - LENGTH 100 MM	48	48-51
DIE SET N. 51 - LENGTH 110 MM	51	51-57
DIE SET N. 54 - LENGTH 110 MM	54	54-57
DIE SET N. 57 - LENGTH 110 MM	57	57-62
DIE SET N. 60 - LENGTH 110 MM	60	60-62
DIE SET N. 62 - LENGTH 110 MM	62	62-66
DIE SET N. 62* - LENGTH 125 MM	62*	62-66
DIE SET N. 66 - LENGTH 110 MM	66	66-70
DIE SET N. 66* - LENGTH 125 MM	66*	66-70
DIE SET N. 70 - LENGTH 100 MM	70	70-72
DIE SET N. 70* - LENGTH 125 MM	70*	70-72
DIE SET N. 73 - LENGTH 125-28 MM, REINFORCED PIN	73	73-76
DIE SET N. 76 - LENGTH 125 MM	76	76-86
DIE SET N. 76* - LENGTH 135 MM	76*	76-86
DIE SET N. 80 - LENGTH 125 MM	80	80-82
DIE SET N. 82 - LENGTH 135 MM	82	82-90
DIE SET N. 86* - LENGTH 150 MM (FOR DIAMONDSPIR 2½")	86*	86-90
DIE SET N. 90 - LENGTH 125 MM	90	90-95
DIE SET N. 95 - LENGTH 150 MM (FOR DIAMONDSPIR 2½")	95*	95-105
DIE SET N. 99 - LENGTH 125 MM	99	95-105
DIE SET N. 105 - LENGTH 150 MM	105	99-109
DIE SET N. 112 - LENGTH 150 MM	112	112-122
DIE SET N. 117 - LENGTH 110 MM	117	117-127
DIE SET N. 122 - LENGTH 130 MM, REINFORCED PIN	122	122-130
KIT 13 DIE SET GOLDENCRIMP ₄₅₀ EVO (15 TO 73)	-	-
KIT 19 DIE SET GOLDENCRIMP₄₅₀EVO (15 TO 76)	-	-

- REFERENCES IN BOLD ARE INCLUDED IN THE STANDARD DIE KIT (ALSO IN BOLD)

MRV 137 EVO R

PG. 30

DESCRIPTION	N°	CRIMP RANGE
DIE SET N. 4 - LENGTH 56 MM	4	04-05
DIE SET N. 6 - LENGTH 56 MM	6	06-08
DIE SET N. 7 - LENGTH 56 MM	7	07-08
DIE SET N. 8 - LENGTH 56 MM	8	08-10
DIE SET N. 9 - LENGTH 56 MM	9	09-10
DIE SET N. 10 - LENGTH 56 MM	10	10-12
DIE SET N. 12 - LENGTH 56 MM	12	12-15
DIE SET N. 14 - LENGTH 56 MM	14	14-15
DIE SET N. 15 - LENGTH 56 MM	15	15-18
DIE SET N. 17 - LENGTH 56 MM	17	17-18
DIE SET N. 18 - LENGTH 56 MM	18	18-21
DIE SET N. 20 - LENGTH 56 MM	20	20-21
DIE SET N. 21 - LENGTH 56 MM	21	21-24
DIE SET N. 24 - LENGTH 56 MM	24	24-27
DIE SET N. 27 - LENGTH 56 MM	27	27-30
DIE SET N. 30 - LENGTH 56 MM	30	30-33
DIE SET N. 33 - LENGTH 70 MM	33	33-36
DIE SET N. 36 - LENGTH 75 MM	36	36-39
DIE SET N. 39 - LENGTH 70 MM	39	39-42
DIE SET N. 42 - LENGTH 70 MM	42	42-45
DIE SET N. 45 - LENGTH 70 MM	45	45-48
DIE SET N. 48 - LENGTH 70 MM	48	48-51
DIE SET N. 51 - LENGTH 75 MM	51	51-57
KIT 4 DIES MVB137EVOR (N.15 TO N.33)	-	-
KIT 5 DIES MVB137EVOR (N.15 TO N.39)	-	-
KIT 6 DIES MVB137EVOR (N.15 TO N.39)	-	-
KIT 7 DIES MVB137EVOR (N.15 TO N.39)	-	-
KIT 9 DIES MVB137EVOR (N.15 TO N.45)	-	-
KIT 9 DIES MVB137EVOR (N.15 TO N.48)	-	-
KIT 10 DIES MVB137EVOR (N.15 TO N.48)	-	-
KIT 13 DIES MVB137EVOR (N.15 TO N.51)	-	-

MV 137 L

PG. 31

DESCRIPTION	N°	CRIMP RANGE
DIE SET N. 4 - LENGTH 56 MM	4	04-05
DIE SET N. 6 - LENGTH 56 MM	6	06-08
DIE SET N. 8 - LENGTH 56 MM	8	08-10
DIE SET N. 10 - LENGTH 56 MM	10	10-12
DIE SET N. 12 - LENGTH 56 MM	12	12-15
DIE SET N. 15 - LENGTH 56 MM	15	15-18
DIE SET N. 17 - LENGTH 56 MM	17	17-18
DIE SET N. 18 - LENGTH 56 MM	18	18-21
DIE SET N. 20 - LENGTH 56 MM	20	20-21
DIE SET N. 21 - LENGTH 56 MM	21	21-24
DIE SET N. 24 - LENGTH 56 MM	24	24-27
DIE SET N. 27 - LENGTH 56 MM	27	27-30
DIE SET N. 30 - LENGTH 56 MM	30	30-33
DIE SET N. 33 - LENGTH 70 MM	33	33-36
DIE SET N. 36 - LENGTH 75 MM	36	36-39
DIE SET N. 39 - LENGTH 70 MM	39	39-42
DIE SET N. 42 - LENGTH 70 MM	42	42-45
DIE SET N. 45 - LENGTH 70 MM	45	45-48
DIE SET N. 48 - LENGTH 70 MM	48	48-51
DIE SET N. 51 - LENGTH 75 MM	51	51-57
KIT 4 DIES MV137L (N.15 TO N.33)	-	-
KIT 5 DIES MV137L (N.15 TO N.39)	-	-
KIT 6 DIES MV137L (N.15 TO N.39)	-	-
KIT 7 DIES MV137L (N.15 TO N.39)	-	-
KIT 9 DIES MV137L (N.15 TO N.45)	-	-
KIT 9 DIES MV137L (N.15 TO N.48)	-	-
KIT 10 DIES MV137L (N.15 TO N.48)	-	-
KIT 13 DIES MV137L (N.15 TO N.51)	-	-

DESCRIPTION	N°	CRIMP RANGE
DIE SET N. 4 - LENGTH 56 MM	4	04-05
DIE SET N. 6 - LENGTH 56 MM	6	06-08
DIE SET N. 7 - LENGTH 56 MM	7	07-08
DIE SET N. 8 - LENGTH 56 MM	8	08-09
DIE SET N. 9 - LENGTH 56 MM	9	09-10
DIE SET N. 10 - LENGTH 56 MM	10	10-12
DIE SET N. 12 - LENGTH 56 MM	12	12-15
DIE SET N. 14 - LENGTH 56 MM	14	14-15
DIE SET N. 15 - LENGTH 56 MM	15	15-18
DIE SET N. 17 - LENGTH 56 MM	17	17-18
DIE SET N. 18 - LENGTH 56 MM	18	18-21
DIE SET N. 20 - LENGTH 56 MM	20	17-18
DIE SET N. 21 - LENGTH 56 MM	21	21-24
DIE SET N. 24 - LENGTH 70 MM	24	24-27
DIE SET N. 27 - LENGTH 90 MM	27	27-30
DIE SET N. 30 - LENGTH 90 MM	30	30-33
DIE SET N. 33 - LENGTH 90 MM	33	33-36
DIE SET N. 36 - LENGTH 90 MM	36	36-39
DIE SET N. 39 - LENGTH 90 MM	39	39-42
DIE SET N. 42 - LENGTH 90 MM	42	42-45
DIE SET N. 45 - LENGTH 100 MM	45	45-48
DIE SET N. 48 - LENGTH 100 MM	48	48-51
DIE SET N. 51 - LENGTH 100 MM	51	51-57
DIE SET N. 54 - LENGTH 100 MM	54	54-57
DIE SET N. 57 - LENGTH 100 MM	57	57-62
DIE SET N. 60 - LENGTH 100 MM	60	60-62
DIE SET N. 62 - LENGTH 100 MM	62	62-66
DIE SET N. 66 - LENGTH 100 MM	66	66-70
DIE SET N. 70 - LENGTH 100 MM	70	70-72
DIE SET N. 72 - LENGTH 100 MM	72	72-80
KIT 9 DIES MV240 (N.15 TO N.51)	-	-
KIT 11 DIES MV240 (N.15 TO N.66)	-	-
KIT 12 DIES MV240 (N.15 TO N.66)	-	-
KIT 17 DIES MV240 (N.15 TO N.70)	-	-

- REFERENCES IN **BOLD** ARE INCLUDED IN THE STANDARD DIE KIT (ALSO IN **BOLD**)

MV 240 L

PG. 33

DESCRIPTION	N°	CRIMP RANGE
DIE SET N. 4 - LENGTH 56 MM	4	04-05
DIE SET N. 6 - LENGTH 56 MM	6	06-08
DIE SET N. 7 - LENGTH 56 MM	7	07-08
DIE SET N. 8 - LENGTH 56 MM	8	08-09
DIE SET N. 9 - LENGTH 56 MM	9	09-10
DIE SET N. 10 - LENGTH 56 MM	10	10-12
DIE SET N. 12 - LENGTH 56 MM	12	12-15
DIE SET N. 15 - LENGTH 56 MM	15	15-18
DIE SET N. 18 - LENGTH 56 MM	18	18-21
DIE SET N. 21 - LENGTH 56 MM	21	21-24
DIE SET N. 24 - LENGTH 70 MM	24	24-27
DIE SET N. 27 - LENGTH 90 MM	27	27-30
DIE SET N. 30 - LENGTH 90 MM	30	30-33
DIE SET N. 33 - LENGTH 90 MM	33	33-36
DIE SET N. 36 - LENGTH 90 MM	36	36-39
DIE SET N. 39 - LENGTH 90 MM	39	39-42
DIE SET N. 42 - LENGTH 90 MM	42	42-45
DIE SET N. 45 - LENGTH 100 MM	45	45-48
DIE SET N. 48 - LENGTH 100 MM	48	48-51
DIE SET N. 51 - LENGTH 100 MM	51	51-57
DIE SET N. 54 - LENGTH 100 MM	54	54-57
DIE SET N. 57 - LENGTH 100 MM	57	57-62
DIE SET N. 62 - LENGTH 100 MM	62	62-66
DIE SET N. 66 - LENGTH 100 MM	66	66-70
DIE SET N. 70 - LENGTH 100 MM	70	70-72
KIT 9 DIES MV240L (N.15 TO N.51)	-	-
KIT 11 DIES MV240L (N.15 TO N.66)	-	-
KIT 12 DIES MV240L (N.15 TO N.66)	-	-
KIT 17 DIES MV240L (N.15 TO N.70)	-	-

DESCRIPTION	N°	CRIMP RANGE
DIE SET N. 4 - LENGTH 56 MM	4	04-05
DIE SET N. 6 - LENGTH 56 MM	6	06-08
DIE SET N. 7 - LENGTH 56 MM	7	07-08
DIE SET N. 8 - LENGTH 56 MM	8	08-09
DIE SET N. 9 - LENGTH 56 MM	9	09-10
DIE SET N. 10 - LENGTH 56 MM	10	10-12
DIE SET N. 12 - LENGTH 56 MM	12	12-15
DIE SET N. 14 - LENGTH 56 MM	14	14-15
DIE SET N. 15 - LENGTH 56 MM	15	15-18
DIE SET N. 17 - LENGTH 56 MM	17	17-18
DIE SET N. 18 - LENGTH 56 MM	18	18-21
DIE SET N. 20 - LENGTH 56 MM	20	17-18
DIE SET N. 21 - LENGTH 56 MM	21	21-24
DIE SET N. 24 - LENGTH 70 MM	24	24-27
DIE SET N. 27 - LENGTH 90 MM	27	27-30
DIE SET N. 30 - LENGTH 90 MM	30	30-33
DIE SET N. 33 - LENGTH 90 MM	33	33-36
DIE SET N. 36 - LENGTH 90 MM	36	36-39
DIE SET N. 39 - LENGTH 90 MM	39	39-42
DIE SET N. 42 - LENGTH 90 MM	42	42-45
DIE SET N. 45 - LENGTH 100 MM	45	45-48
DIE SET N. 48 - LENGTH 100 MM	48	48-51
DIE SET N. 51 - LENGTH 100 MM	51	51-57
DIE SET N. 54 - LENGTH 110 MM	54	54-57
DIE SET N. 57 - LENGTH 100 MM	57	57-62
DIE SET N. 54 - LENGTH 110 MM	54	54-57
DIE SET N. 62 - LENGTH 100 MM	62	62-66
DIE SET N. 66 - LENGTH 110 MM	66	66-70
DIE SET N. 70 - LENGTH 100 MM	70	70-72
DIE SET N. 73 - LENGTH 125 MM	73	73-76
DIE SET N. 75 - LENGTH 125 MM	75	75-76
DIE SET N. 76 - LENGTH 125 MM	76	76-86
DIE SET N. 80 - LENGTH 125 MM	80	80-86
DIE SET N. 86 - LENGTH 125 MM	86	86-90
DIE SET N. 90 - LENGTH 125 MM	90	90-95
DIE SET N. 95 - LENGTH 125 MM	95	95-105
DIE SET N. 99 - LENGTH 125 MM	99	99-109
DIE SET N. 112 - LENGTH 125 MM	112	112-117
DIE SET N. 117 - LENGTH 125 MM	117	117-122
DIE SET N. 122 - LENGTH 125 MM	122	122-127
KIT 12 DIES MV350 (N.15 TO N.66)	-	-
KIT 17 DIES MV350 (N.15 TO N.70)	-	-

- REFERENCES IN **BOLD** ARE INCLUDED IN THE STANDARD DIE KIT (ALSO IN **BOLD**)

MV 350 L

PG. 34

DESCRIPTION	N°	CRIMP RANGE
DIE SET N. 4 - LENGTH 56 MM	4	04-05
DIE SET N. 6 - LENGTH 56 MM	6	06-08
DIE SET N. 7 - LENGTH 56 MM	7	07-08
DIE SET N. 8 - LENGTH 56 MM	8	08-09
DIE SET N. 9 - LENGTH 56 MM	9	09-10
DIE SET N. 10 - LENGTH 56 MM	10	10-12
DIE SET N. 12 - LENGTH 56 MM	12	12-15
DIE SET N. 14 - LENGTH 56 MM	14	14-15
DIE SET N. 15 - LENGTH 56 MM	15	15-18
DIE SET N. 17 - LENGTH 56 MM	17	17-18
DIE SET N. 18 - LENGTH 56 MM	18	18-21
DIE SET N. 20 - LENGTH 56 MM	20	17-18
DIE SET N. 21 - LENGTH 56 MM	21	21-24
DIE SET N. 24 - LENGTH 70 MM	24	24-27
DIE SET N. 27 - LENGTH 90 MM	27	27-30
DIE SET N. 30 - LENGTH 90 MM	30	30-33
DIE SET N. 33 - LENGTH 90 MM	33	33-36
DIE SET N. 36 - LENGTH 90 MM	36	36-39
DIE SET N. 39 - LENGTH 90 MM	39	39-42
DIE SET N. 42 - LENGTH 90 MM	42	42-45
DIE SET N. 45 - LENGTH 100 MM	45	45-48
DIE SET N. 48 - LENGTH 100 MM	48	48-51
DIE SET N. 51 - LENGTH 100 MM	51	51-57
DIE SET N. 54 - LENGTH 110 MM	54	54-57
DIE SET N. 57 - LENGTH 100 MM	57	57-62
DIE SET N. 54 - LENGTH 110 MM	54	54-57
DIE SET N. 62 - LENGTH 100 MM	62	62-66
DIE SET N. 66 - LENGTH 110 MM	66	66-70
DIE SET N. 70 - LENGTH 100 MM	70	70-72
DIE SET N. 73 - LENGTH 125 MM	73	73-76
DIE SET N. 75 - LENGTH 125 MM	75	75-76
DIE SET N. 76 - LENGTH 125 MM	76	76-86
DIE SET N. 80 - LENGTH 125 MM	80	80-86
DIE SET N. 86 - LENGTH 125 MM	86	86-90
DIE SET N. 90 - LENGTH 125 MM	90	90-95
DIE SET N. 95 - LENGTH 125 MM	95	95-105
DIE SET N. 99 - LENGTH 125 MM	99	99-109
DIE SET N. 112 - LENGTH 125 MM	112	112-117
DIE SET N. 117 - LENGTH 125 MM	117	117-122
DIE SET N. 122 - LENGTH 125 MM	122	122-127
KIT 12 DIES MV350L (N.15 TO N.66)	-	-
KIT 17 DIES MV350L (N.15 TO N.70)	-	-

DESCRIPTION	N°	CRIMP RANGE
DIE SET N. 4 - LENGTH 56 MM	4	04-05
DIE SET N. 6 - LENGTH 56 MM	6	06-08
DIE SET N. 7 - LENGTH 56 MM	7	07-08
DIE SET N. 8 - LENGTH 56 MM	8	08-09
DIE SET N. 9 - LENGTH 56 MM	9	09-10
DIE SET N. 10 - LENGTH 56 MM	10	10-12
DIE SET N. 12 - LENGTH 70 MM	12	12-15
DIE SET N. 14 - LENGTH 70 MM	14	14-15
DIE SET N. 15 - LENGTH 70 MM	15	15-18
DIE SET N. 17 - LENGTH 70 MM	17	17-18
DIE SET N. 18 - LENGTH 70 MM	18	18-21
DIE SET N. 20 - LENGTH 70 MM	20	20-21
DIE SET N. 21 - LENGTH 70 MM	21	21-24
DIE SET N. 24 - LENGTH 70 MM	24	24-27
DIE SET N. 27 - LENGTH 70 MM	27	27-30
DIE SET N. 30 - LENGTH 70 MM	30	30-33
DIE SET N. 33 - LENGTH 70 MM	33	33-36
DIE SET N. 36 - LENGTH 75 MM	36	36-39
DIE SET N. 39 - LENGTH 70 MM	39	39-42
DIE SET N. 42 - LENGTH 70-28 MM	42	42-45
DIE SET N. 45 - LENGTH 70 MM	45	45-48
DIE SET N. 48 - LENGTH 70 MM	48	48-51
DIE SET N. 51 - LENGTH 75 MM	51	51-57
KIT 10 DIES MS200 (N.15 TO N.48)	-	-
KIT 12 DIES MS200 (N.15 TO N.48)	-	-

MS 320

PG. 37

DESCRIPTION	N°	CRIMP RANGE
DIE SET N. 4 - LENGTH 56 MM	4	04-05
DIE SET N. 6 - LENGTH 56 MM	6	06-08
DIE SET N. 7 - LENGTH 56 MM	7	07-08
DIE SET N. 8 - LENGTH 56 MM	8	08-09
DIE SET N. 10 - LENGTH 90 MM	10	10-12
DIE SET N. 12 - LENGTH 90 MM	12	12-15
DIE SET N. 14 - LENGTH 90 MM	14	14-15
DIE SET N. 15 - LENGTH 70 MM	15	15-18
DIE SET N. 17 - LENGTH 90 MM	17	17-18
DIE SET N. 18 - LENGTH 70 MM	18	18-21
DIE SET N. 20 - LENGTH 90 MM	20	20-21
DIE SET N. 21 - LENGTH 90 MM	21	21-24
DIE SET N. 24 - LENGTH 90 MM	24	24-27
DIE SET N. 27 - LENGTH 90 MM	27	27-30
DIE SET N. 30 - LENGTH 90 MM	30	30-33
DIE SET N. 33 - LENGTH 90 MM	33	33-36
DIE SET N. 36 - LENGTH 90 MM	36	36-39
DIE SET N. 39 - LENGTH 90 MM	39	39-42
DIE SET N. 42 - LENGTH 90 MM	42	42-45
DIE SET N. 45 - LENGTH 95 MM	45	45-48
DIE SET N. 48 - LENGTH 100 MM	48	48-51
DIE SET N. 51 - LENGTH 100 MM	51	51-57
DIE SET N. 54 - LENGTH 100 MM	54	54-57
DIE SET N. 57 - LENGTH 100 MM	57	57-62
DIE SET N. 60 - LENGTH 100 MM	60	60-62
DIE SET N. 62 - LENGTH 110 MM	62	62-66
DIE SET N. 62 - LENGTH 125 MM	62	62-66
DIE SET N. 66 - LENGTH 100 MM	66	66-70
DIE SET N. 66 - LENGTH 125 MM	66	66-70
DIE SET N. 70 - LENGTH 100 MM	70	70-72
DIE SET N. 70 - LENGTH 125 MM	70	70-72
DIE SET N. 73 - LENGTH 120 MM	73	73-76
DIE SET N. 76 - LENGTH 120 MM	76	76-86
DIE SET N. 80 - LENGTH 100 MM	80	80-86
DIE SET N. 86 - LENGTH 100-65 MM	86	86-90
DIE SET N. 90 - LENGTH 100 MM, REINFORCED PIN	90	90-95
DIE SET N. 95 - LENGTH 100 MM, REINFORCED PIN	95	95-105
DIE SET N. 99 - LENGTH 100 MM	99	99-109
DIE SET N. 112 - LENGTH 100 MM	112	112-117
DIE SET N. 117 - LENGTH 100 MM	117	117-122
DIE SET N. 122 - LENGTH 100 MM	122	122-127
KIT 13 DIES MS320 (N.15 TO N.73)	-	-
KIT 19 DIES MS320 (N.15 TO N.76)	-	-

DESCRIPTION	N°	CRIMP RANGE
DIE SET N. 4 - LENGTH 56 MM	4	04-05
DIE SET N. 6 - LENGTH 56 MM	6	06-08
DIE SET N. 7 - LENGTH 56 MM	7	07-08
DIE SET N. 8 - LENGTH 56 MM	8	08-09
DIE SET N. 10 - LENGTH 90 MM	10	10-12
DIE SET N. 12 - LENGTH 90 MM	12	12-15
DIE SET N. 14 - LENGTH 90 MM	14	14-15
DIE SET N. 15 - LENGTH 90 MM	15	15-18
DIE SET N. 17 - LENGTH 90 MM	17	17-18
DIE SET N. 18 - LENGTH 90 MM	18	18-21
DIE SET N. 20 - LENGTH 90 MM	20	20-21
DIE SET N. 21 - LENGTH 90 MM	21	21-24
DIE SET N. 24 - LENGTH 90 MM	24	24-27
DIE SET N. 27 - LENGTH 90 MM	27	27-30
DIE SET N. 30 - LENGTH 100 MM	30	30-33
DIE SET N. 33 - LENGTH 90 MM	33	33-36
DIE SET N. 36 - LENGTH 90 MM	36	36-39
DIE SET N. 39 - LENGTH 90 MM	39	39-42
DIE SET N. 42 - LENGTH 90 MM	42	42-45
DIE SET N. 45 - LENGTH 100 MM	45	45-48
DIE SET N. 48 - LENGTH 100 MM	48	48-51
DIE SET N. 51 - LENGTH 110 MM	51	51-57
DIE SET N. 54 - LENGTH 110 MM	54	54-57
DIE SET N. 57 - LENGTH 110 MM	57	57-62
DIE SET N. 60 - LENGTH 110 MM	60	60-62
DIE SET N. 62 - LENGTH 110 MM	62	62-66
DIE SET N. 62* - LENGTH 125 MM	62*	62-66
DIE SET N. 66 - LENGTH 110 MM	66	66-70
DIE SET N. 66* - LENGTH 125 MM	66*	66-70
DIE SET N. 70 - LENGTH 110 MM	70	70-72
DIE SET N. 70* - LENGTH 125 MM	70*	70-72
DIE SET N. 73 - LENGTH 125-28 MM, REINFORCED PIN	73	73-76
DIE SET N. 76 - LENGTH 135 MM	76	76-86
DIE SET N. 80 - LENGTH 125 MM	80	80-86
DIE SET N. 82 - LENGTH 135 MM	82	82-90
DIE SET N. 86 - LENGTH 150 MM	86	86-90
DIE SET N. 86 - LENGTH 125-48 MM	86	
DIE SET N. 90 - LENGTH 125 MM	90	90-95
DIE SET N. 95 - LENGTH 150 MM	95	95-105
DIE SET N. 95 - LENGTH 125-48 MM	95	
DIE SET N. 99 - LENGTH 125 MM, REINFORCED PIN	99	99-105
DIE SET N. 105 - LENGTH 150 MM	105	105-112
DIE SET N. 112 - LENGTH 150 MM	112	112-122
DIE SET N. 117 - LENGTH 125 MM	117	117-122
DIE SET N. 122 - LENGTH 130 MM, REINFORCED PIN	122	122-130
DIE SET N. 130 - LENGTH 145 MM	130	130-140
KIT 13 DIES MS480 (N.15 TO N.73)	-	-
KIT 19 DIES MS480 (N.15 TO N.76)	-	-

- REFERENCES IN BOLD ARE INCLUDED IN THE STANDARD DIE KIT (ALSO IN BOLD)

MS 800

PG. 39

DESCRIPTION	N°	CRIMP RANGE
DIE SET N. 4 - LENGTH 56 MM	4	04-05
DIE SET N. 6 - LENGTH 56 MM	6	06-08
DIE SET N. 7 - LENGTH 56 MM	7	07-08
DIE SET N. 8 - LENGTH 56 MM	8	08-09
DIE SET N. 10 - LENGTH 56 MM	10	10-12
DIE SET N. 12 - LENGTH 90 MM	12	12-15
DIE SET N. 15 - LENGTH 90 MM	15	15-18
DIE SET N. 17 - LENGTH 90 MM	17	17-18
DIE SET N. 18 - LENGTH 90 MM	18	18-21
DIE SET N. 20 - LENGTH 90 MM	20	20-21
DIE SET N. 21 - LENGTH 90 MM	21	21-24
DIE SET N. 24 - LENGTH 90 MM	24	24-27
DIE SET N. 27 - LENGTH 90 MM	27	27-30
DIE SET N. 30 - LENGTH 90 MM	30	30-33
DIE SET N. 33 - LENGTH 90 MM	33	33-36
DIE SET N. 36 - LENGTH 90 MM	36	36-39
DIE SET N. 39 - LENGTH 90 MM	39	39-42
DIE SET N. 42 - LENGTH 90 MM	42	42-45
DIE SET N. 45 - LENGTH 100 MM	45	45-48
DIE SET N. 48 - LENGTH 100 MM	48	48-51
DIE SET N. 51 - LENGTH 110 MM	51	51-57
DIE SET N. 54 - LENGTH 110 MM	54	54-57
DIE SET N. 57 - LENGTH 110 MM	57	57-62
DIE SET N. 60 - LENGTH 110 MM	60	60-62
DIE SET N. 62 - LENGTH 110 MM	62	62-66
DIE SET N. 62* - LENGTH 125 MM	62*	62-66
DIE SET N. 66 - LENGTH 110 MM	66	66-70
DIE SET N. 66* - LENGTH 125 MM	66*	66-70
DIE SET N. 70 - LENGTH 110 MM	70	70-72
DIE SET N. 70* - LENGTH 125 MM	70*	70-72
DIE SET N. 73 - LENGTH 125-28 MM, REINFORCED PIN	73	73-76
DIE SET N. 76 - LENGTH 125 MM	76	76-86
DIE SET N. 76* - LENGTH 135 MM	76*	76-86
DIE SET N. 80 - LENGTH 125 MM	80	80-86
DIE SET N. 82 - LENGTH 135 MM	82	82-90
DIE SET N. 86 - LENGTH 150 MM	86	86-90
DIE SET N. 90 - LENGTH 125 MM	90	90-95
DIE SET N. 95 - LENGTH 150 MM	95	95-105
DIE SET N. 105 - LENGTH 180 MM	105	105-112
DIE SET N. 112 - LENGTH 150 MM	112	112-122
DIE SET N. 130 - LENGTH 180 MM	130	130-140
KIT 13 DIES MS800 (N.15 TO N.73)	-	-
KIT 18 DIES MS800 (N.39 TO N.130)	-	-

MS 320 OPEN HEAD

PG. 40

DESCRIPTION	N°	CRIMP RANGE
DIE SET N. 73 - LENGTH 125 MM	73	73-80
DIE SET N. 80 - LENGTH 125 MM	80	80-86
DIE SET N. 84 - LENGTH 125 MM	84	86-90
DIE SET N. 86 - LENGTH 125 MM	86	86-90
DIE SET N. 90 - LENGTH 125 MM	90	90-95
DIE SET N. 95 - LENGTH 125 MM	95	95-105
DIE SET N. 99 - LENGTH 125 MM	99	99-106
DIE SET N. 106 - LENGTH 125 MM	106	106-112
DIE SET N. 112 - LENGTH 125 MM	112	112-117
DIE SET N. 117 - LENGTH 125 MM	117	117-122
DIE SET N. 122 - LENGTH 125 MM	122	122-125
DIE SET N.125 - LENGTH 125 MM	125	125-128
DIE SET N. 128 - LENGTH 125 MM	128	128-130
DIE SET N. 130 - LENGTH 125 MM	130	130-140
DIE SET N. 135 - LENGTH 125 MM	135	135-145
DIE SET N. 150 - LENGTH 125 MM	150	150-160
DIE SET N. 156 - LENGTH 125 MM	156	156-166
DIE SET N. 158 - LENGTH 125 MM	158	158-168
DIE SET N. 165 - LENGTH 125 MM	165	165-185
DIE SET N. 175 - LENGTH 125 MM	175	175-195
DIE SET N. 181 - LENGTH 125 MM	181	181-201
DIE SET N. 185 - LENGTH 125 MM	185	185-205
DIE SET N. 188 - LENGTH 125 MM	188	188-208
DIE SET N. 190 - LENGTH 125 MM	190	190-210

MS 400

PG. 41

DESCRIPTION	N°	CRIMP RANGE
DIE SET N. 4 - LENGTH 56 MM	4	04-05
DIE SET N. 6 - LENGTH 56 MM	6	06-08
DIE SET N. 7 - LENGTH 56 MM	7	07-08
DIE SET N. 8 - LENGTH 56 MM	8	08-09
DIE SET N. 10 - LENGTH 56 MM	10	10-12
DIE SET N. 12 - LENGTH 56 MM	12	12-15
DIE SET N. 15 - LENGTH 56 MM	15	15-18
DIE SET N. 17 - LENGTH 56 MM	17	17-18
DIE SET N. 18 - LENGTH 56MM	18	18-21
DIE SET N. 20 - LENGTH 56 MM	20	20-21
DIE SET N. 21 - LENGTH 56 MM	21	21-24
DIE SET N. 24 - LENGTH 70 MM	24	24-27
DIE SET N. 27 - LENGTH 90 MM	27	27-30
DIE SET N. 30 - LENGTH 90 MM	30	30-33
DIE SET N. 33 - LENGTH 90 MM	33	33-36
DIE SET N. 36 - LENGTH 90 MM	36	36-39
DIE SET N. 39 - LENGTH 90 MM	39	39-42
DIE SET N. 42 - LENGTH 90 MM	42	42-45
DIE SET N. 45 - LENGTH 100 MM	45	45-48
DIE SET N. 48 - LENGTH 100 MM	48	48-51
DIE SET N. 51 - LENGTH 110 MM	51	51-57
DIE SET N. 54 - LENGTH 110 MM	54	36-39
DIE SET N. 57 - LENGTH 110 MM	57	57-62
DIE SET N. 60 - LENGTH 110 MM	60	60-62
DIE SET N. 66 - LENGTH 125 MM	66	66-70
DIE SET N. 73 - LENGTH 125 MM	73	73-80
DIE SET N. 80 - LENGTH 125 MM	80	80-86
DIE SET N. 86 - LENGTH 125 MM	86	86-90
DIE SET N. 90 - LENGTH 125 MM	90	90-95
DIE SET N. 95 - LENGTH 125 MM	95	95-105
DIE SET N. 99 - LENGTH 125 MM	99	99-112
DIE SET N. 112 - LENGTH 125 MM	112	112-117
DIE SET N. 117 - LENGTH 125 MM	117	117-122
DIE SET N. 122 - LENGTH 125 MM	122	122-130
DIE SET N. 130 - LENGTH 150 MM	130	130-140
DIE SET N. 136 - LENGTH 150 MM	136	136-146
DIE SET N. 146 - LENGTH 150 MM	146	146-156
DIE SET N. 156 - LENGTH 150 MM	156	156-166
DIE SET N. 166 - LENGTH 150 MM	166	166-176
DIE SET N. 176 - LENGTH 150 MM	176	176-186
DIE SET N. 186 - LENGTH 150 MM	186	186-196
DIE SET N. 196 - LENGTH 150 MM	196	196-206

MS 450-200

PG. 42

DESCRIPTION	N°	CRIMP RANGE
DIE SET N. 4 - LENGTH 56 MM	4	04-05
DIE SET N. 6 - LENGTH 56 MM	6	06-08
DIE SET N. 7 - LENGTH 56 MM	7	07-08
DIE SET N. 8 - LENGTH 56 MM	8	08-09
DIE SET N. 10 - LENGTH 56 MM	10	10-12
DIE SET N. 12 - LENGTH 56 MM	12	12-15
DIE SET N. 15 - LENGTH 56 MM	15	15-18
DIE SET N. 17 - LENGTH 56 MM	17	17-18
DIE SET N. 18 - LENGTH 56 MM	18	18-21
DIE SET N. 20 - LENGTH 56 MM	20	20-21
DIE SET N. 21 - LENGTH 56 MM	21	21-24
DIE SET N. 24 - LENGTH 70 MM	24	24-27
DIE SET N. 27 - LENGTH 90 MM	27	27-30
DIE SET N. 30 - LENGTH 90 MM	30	30-33
DIE SET N. 33 - LENGTH 90 MM	33	33-36
DIE SET N. 36 - LENGTH 90 MM	36	36-39
DIE SET N. 39 - LENGTH 90 MM	39	39-42
DIE SET N. 42 - LENGTH 90 MM	42	42-45
DIE SET N. 45 - LENGTH 100 MM	45	45-48
DIE SET N. 48 - LENGTH 100 MM	48	48-51
DIE SET N. 51 - LENGTH 110 MM	51	51-57
DIE SET N. 54 - LENGTH 110 MM	54	54-57
DIE SET N. 57 - LENGTH 110 MM	57	57-62
DIE SET N. 60 - LENGTH 110 MM	60	60-62
DIE SET N. 62 - LENGTH 110 MM	62	62-66
DIE SET N. 62* - LENGTH 125 MM	62*	62-66
DIE SET N. 66 - LENGTH 110 MM	66	66-70
DIE SET N. 66* - LENGTH 125 MM	66*	66-70
DIE SET N. 70 - LENGTH 100 MM	70	70-72
DIE SET N. 70* - LENGTH 125 MM	70*	70-72
DIE SET N. 73 - LENGTH 125-28 MM, REINFORCED PIN	73	73-76
DIE SET N. 76 - LENGTH 125 MM	76	76-86
DIE SET N. 76* - LENGTH 135 MM	76*	76-86
DIE SET N. 80 - LENGTH 125 MM	80	80-82
DIE SET N. 82 - LENGTH 135 MM	82	82-90
DIE SET N. 86* - LENGTH 150 MM (FOR DIAMONDSPIR 2½")	86*	86-90
DIE SET N. 90 - LENGTH 125 MM	90	90-95
DIE SET N. 95 - LENGTH 150 MM (FOR DIAMONDSPIR 2½")	95*	95-105
DIE SET N. 99 - LENGTH 125 MM	99	95-105
DIE SET N. 105 - LENGTH 150 MM	105	99-109
DIE SET N. 112 - LENGTH 150 MM	112	112-122
DIE SET N. 117 - LENGTH 110 MM	117	117-127
DIE SET N. 122 - LENGTH 130 MM, REINFORCED PIN	122	122-130
KIT 13 DIE SET XLCRIMP ₄₅₀₋₂₀₀ (15 TO 73)	-	-
KIT 19 DIE SET XLCRIMP ₄₅₀₋₂₀₀ (15 TO 76)	-	-

- OTHER DIMENSIONS UPON REQUEST

MS 350

PG. 43

DESCRIPTION	N°	CRIMP RANGE
DIE SET N. 73 - LENGTH 125 MM	73	73-80
DIE SET N. 80 - LENGTH 125 MM	80	80-86
DIE SET N. 86 - LENGTH 125 MM	86	86-90
DIE SET N. 90 - LENGTH 125 MM	90	90-95
DIE SET N. 95 - LENGTH 125 MM	95	95-105
DIE SET N. 99 - LENGTH 125 MM	99	99-112
DIE SET N. 112 - LENGTH 125 MM	112	112-117
DIE SET N. 117 - LENGTH 125 MM	117	117-122
DIE SET N. 122 - LENGTH 125 MM	122	122-130
DIE SET N. 130 - LENGTH 140 MM, REINFORCED PIN	130	130-150
DIE SET N. 169 - LENGTH 140 MM, REINFORCED PIN	169	169-189
DIE SET N. 182 - LENGTH 130 MM, REINFORCED PIN	182	182-202
DIE SET N. 240 - LENGTH 130 MM, REINFORCED PIN	240	240-260

MS 550/MS 550-16

PG. 44

DESCRIPTION	N°	CRIMP RANGE
DIE SET N. 73 - LENGTH 125 MM	73	73-80
DIE SET N. 80 - LENGTH 125 MM	80	80-86
DIE SET N. 86 - LENGTH 125 MM	86	86-90
DIE SET N. 90 - LENGTH 125 MM	90	90-95
DIE SET N. 95 - LENGTH 125 MM	95	95-105
DIE SET N. 99 - LENGTH 125 MM	99	99-112
DIE SET N. 112 - LENGTH 125 MM	112	112-117
DIE SET N. 117 - LENGTH 125 MM	117	117-122
DIE SET N. 122 - LENGTH 125 MM	122	122-130
DIE SET N. 130 - LENGTH 200 MM	130	130-140
DIE SET N. 140 - LENGTH 200 MM	140	140-150
DIE SET N. 150 - LENGTH 200 MM	150	150-160
DIE SET N. 156 - LENGTH 200 MM	156	156-166
DIE SET N. 160 - LENGTH 200 MM	160	160-180
DIE SET N. 165 - LENGTH 200 MM	165	165-185
DIE SET N. 170 - LENGTH 200 MM	170	170-190
DIE SET N. 176 - LENGTH 200 MM	176	176-196
DIE SET N. 178 - LENGTH 200 MM	178	178-198
DIE SET N. 180 - LENGTH 200 MM	180	180-200
DIE SET N. 200 - LENGTH 200 MM	200	200-220
DIE SET N. 215 - LENGTH 200 MM	215	215-235
DIE SET N. 225 - LENGTH 200 MM	225	225-245
DIE SET N. 230 - LENGTH 200 MM	230	230-250
DIE SET N. 235 - LENGTH 200 MM	235	235-255
DIE SET N. 250 - LENGTH 200 MM	250	250-270
DIE SET N. 260 - LENGTH 200 MM	260	260-280
DIE SET N. 265 - LENGTH 200 MM	265	265-285
DIE SET N. 280 - LENGTH 200 MM	280	280-300
DIE SET N. 282 - LENGTH 200 MM	282	282-302
DIE SET N. 285 - LENGTH 200 MM	285	285-305
DIE SET N. 290 - LENGTH 200 MM	290	290-310
DIE SET N. 308 - LENGTH 200 MM	308	308-328
DIE SET N. 317 - LENGTH 200 MM	317	317-337
DIE SET N. 330 - LENGTH 200 MM	330	330-350
DIE SET N. 340 - LENGTH 200 MM	340	340-360

- OTHER DIMENSIONS UPON REQUEST

N CRIMP 70**PG. 58**

DESCRIPTION
SET OF NUT CRIMPING DIES N.12 PEP 108 (N CRIMP)
SET OF NUT CRIMPING DIES N.14 PEP 108 (N CRIMP)
SET OF NUT CRIMPING DIES N.16 PEP 108 (N CRIMP)
SET OF NUT CRIMPING DIES N.19 PEP 108 (N CRIMP)
SET OF NUT CRIMPING DIES N.22 PEP 108 (N CRIMP)
SET OF NUT CRIMPING DIES N.26 PEP 108 (N CRIMP)
SET OF NUT CRIMPING DIES N.30 PEP 108 (N CRIMP)
SET OF NUT CRIMPING DIES N.34 PEP 108 (N CRIMP)
SET OF NUT CRIMPING DIES N.39 PEP 108 (N CRIMP)
SET OF NUT CRIMPING DIES N.45 PEP 108 (N CRIMP)

N CRIMP 80**PG. 58**

DESCRIPTION
SET OF NUT CRIMPING DIES N.12 PEP 158 (N CRIMP)
SET OF NUT CRIMPING DIES N.14 PEP 158 (N CRIMP)
SET OF NUT CRIMPING DIES N.16 PEP 158 (N CRIMP)
SET OF NUT CRIMPING DIES N.19 PEP 158 (N CRIMP)
SET OF NUT CRIMPING DIES N.22 PEP 158 (N CRIMP)
SET OF NUT CRIMPING DIES N.26 PEP 158 (N CRIMP)
SET OF NUT CRIMPING DIES N.30 PEP 158 (N CRIMP)
SET OF NUT CRIMPING DIES N.34 PEP 158 (N CRIMP)
SET OF NUT CRIMPING DIES N.39 PEP 158 (N CRIMP)
SET OF NUT CRIMPING DIES N.45 PEP 158 (N CRIMP)
SET OF NUT CRIMPING DIES N.51 PEP 158 (N CRIMP)
SET OF NUT CRIMPING DIES N.57 PEP 158 (N CRIMP)
SET OF NUT CRIMPING DIES N.63 PEP 158 (N CRIMP)
SET OF NUT CRIMPING DIES N.69 PEP 158 (N CRIMP)
SET OF NUT CRIMPING DIES N.73 PEP 158 (N CRIMP)



www.manuli-hydraulics.com/equipment



Global Marketing Office
Email: marketing@manuli-hydraulics.com

© Copyright 2022 Manuli Hydraulics. All rights reserved.
All product names are either trademarks or registered trademarks of
Manuli Hydraulics or Manuli Rubber Industries unless otherwise stated.